

CASSETTE RECEIVER

KRC-705/759R/R/RY/785/805/  
859C/CY/R/R/RY/W/WY  
/885W/PS955

SERVICE MANUAL

KENWOOD

© 1998-2 PRINTED IN JAPAN  
B51-7309-00(B) 3299

Extension cord	Parts No.
cassette mechism (7P)	W05-0477-00
cassette mechism (10P)	W05-0609-00

KRC-PS955

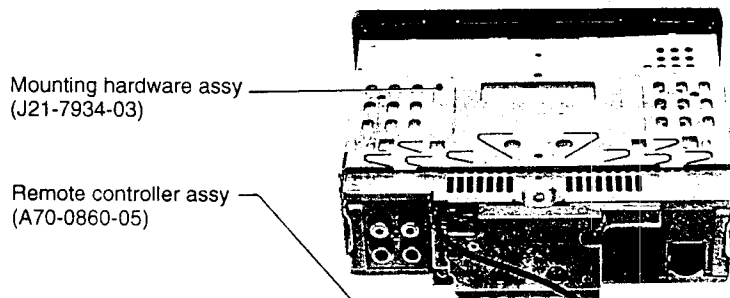
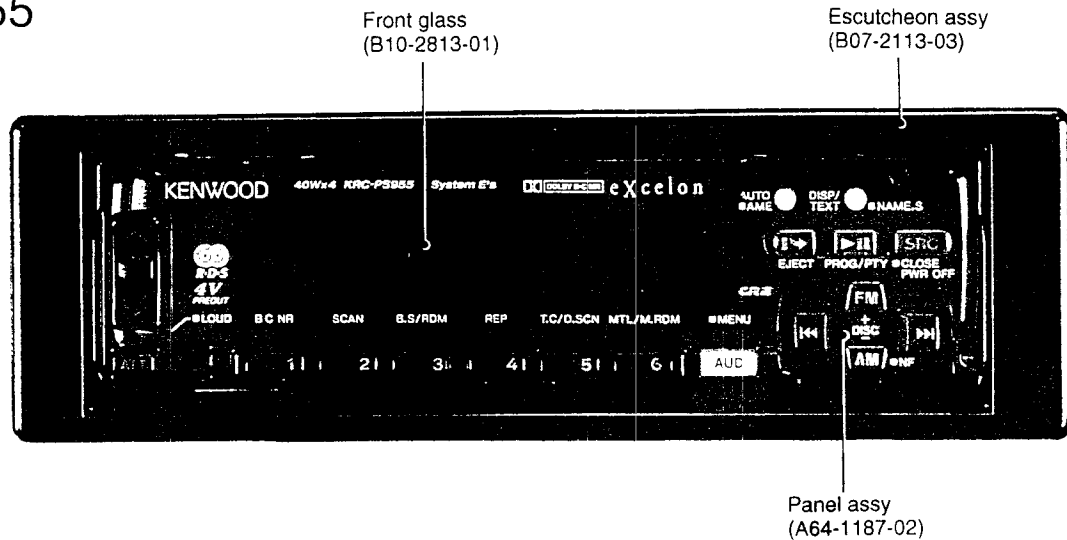

For Service Manuals Contact  
MAURITRON TECHNICAL SERVICES  
8 Cherry Tree Rd, Chinnor  
Oxon OX9 4QY  
Tel: 01844-351694 Fax: 01844-352554  
Email: enquiries@mauritron.co.uk



DC cord (E30-4549-05)



Escutcheon (B07-2096-72)



Sheet (G16-1084-04)

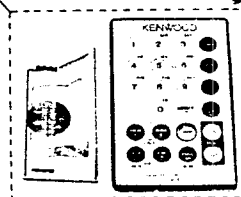

Screw set (N99-1652-05)



Lever (D10-4067-14)

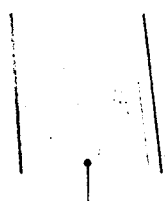

Bracket(L) (J19-4720-04)

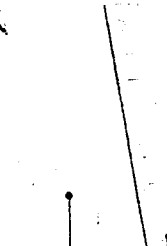

Bracket(R) (J19-4721-04)



Stay (J54-0606-04)

# KRC-705/759R/RV/785/805/859C /CY/R/RV/W/WY/885W/PS955

Service Manuals Contact  
 MAURITRON TECHNICAL SERVICES  
 8 Cherry Tree Road, Chinner  
 Oxon OX9 4QY  
 Tel: 01844-351694 Fax: 01844-352554  
 Email: enquiries@mauritron.co.uk

## KRC-805

Front glass  
 (B10-2814-01)

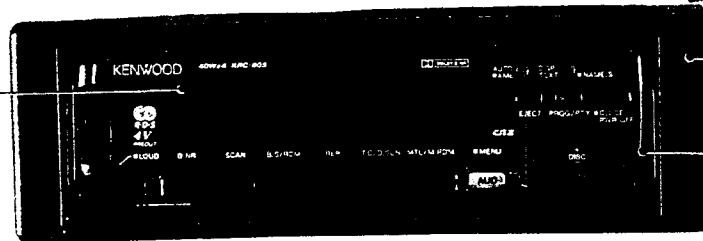

Escutcheon assy  
 (B07-2118-03)

Panel assy  
 (A64-1188-02)

Mounting hardware assy  
 (J21-7934-03)

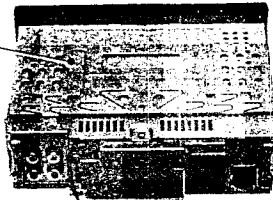

Sheet  
 (G16-1084-04)

Remote controller assy  
 (A70-0860-05)

Escutcheon  
 (B07-2117-02)

Lever  
 (D10-4067-14)

DC cord  
 (E30-4549-05)



Stay  
 (J54-0606-04)

Bracket(R)  
 (J19-4721-04)

Screw set  
 (N99-1652-05)

Bracket(L)  
 (J19-4720-04)

## KRC-705

Front glass  
 (B10-2815-01)

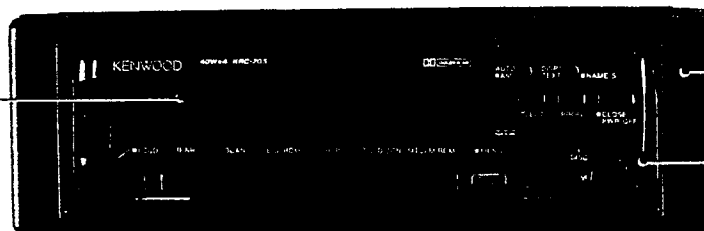

Escutcheon assy  
 (B07-2118-03)

Panel assy  
 (A64-1189-02)

Mounting hardware assy  
 (J21-7934-03)

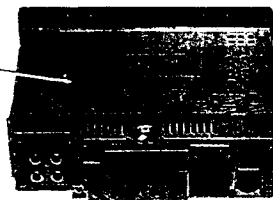

Screw set  
 (N99-1652-05)

Sheet  
 (G16-1084-04)

Lever  
 (D10-4067-14)

Escutcheon  
 (B07-2117-02)

Stay  
 (J54-0606-04)

DC cord  
 (E30-4549-05)

Bracket(R)  
 (J19-4721-04)

Bracket(L)  
 (J19-4720-04)

For Service Manuals Contact  
**MAURITRON TECHNICAL SERVICES**  
 8 Cherry Tree Rd, Chinnor  
 Oxon OX9 4QY  
**Tel:- 01844-351694 Fax:- 01844-352554**  
**Email:- enquiries@mauritron.co.uk**

# KRC-705/759R/RV/785/805/859C /CY/R/RV/W/WY/885W/PS955

## KRC-859R

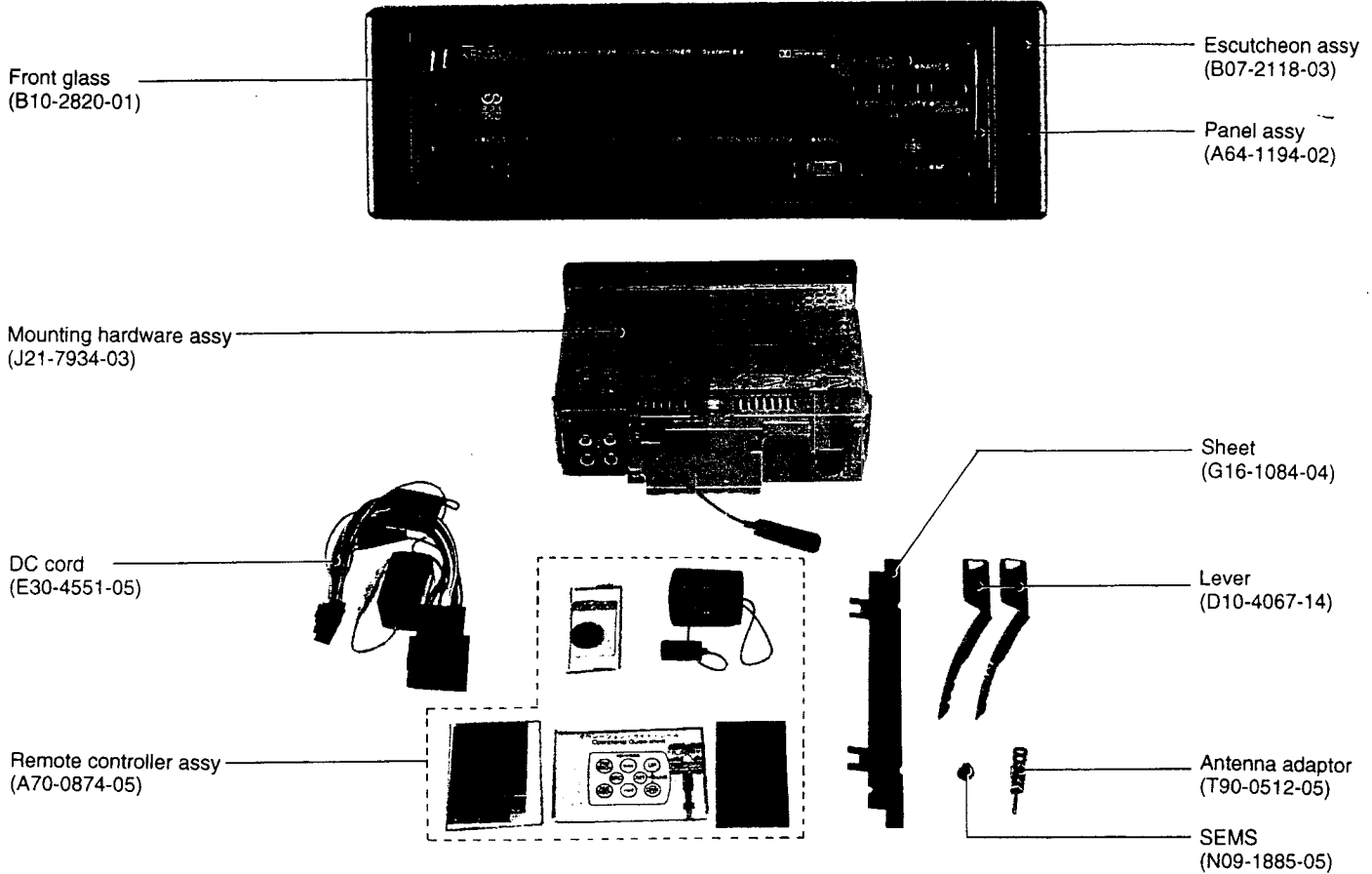

## KRC-859C

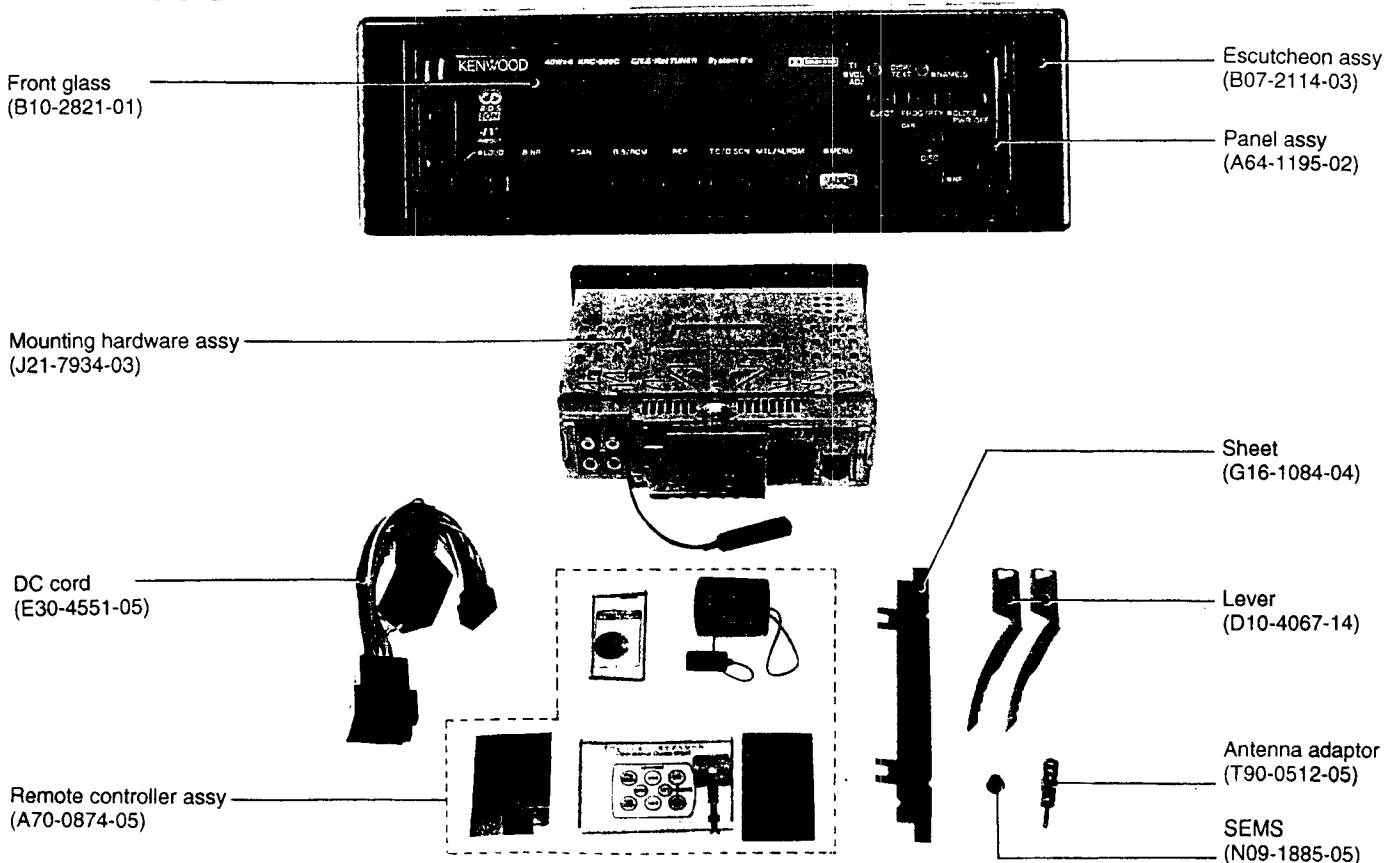

# KRC-705/759R/RV/785/805/859C /CY/R/RV/W/WY/885W/PS955

For Service Manuals Contact  
**MAURITRON TECHNICAL SERVICES**  
 8 Cherry Tree Rd, Chinnor  
 Oxon OX9 4QY  
 Tel:- 01844-351694 Fax:- 01844-352554  
 Email:- enquiries@mauritron.co.uk

## KRC-859W

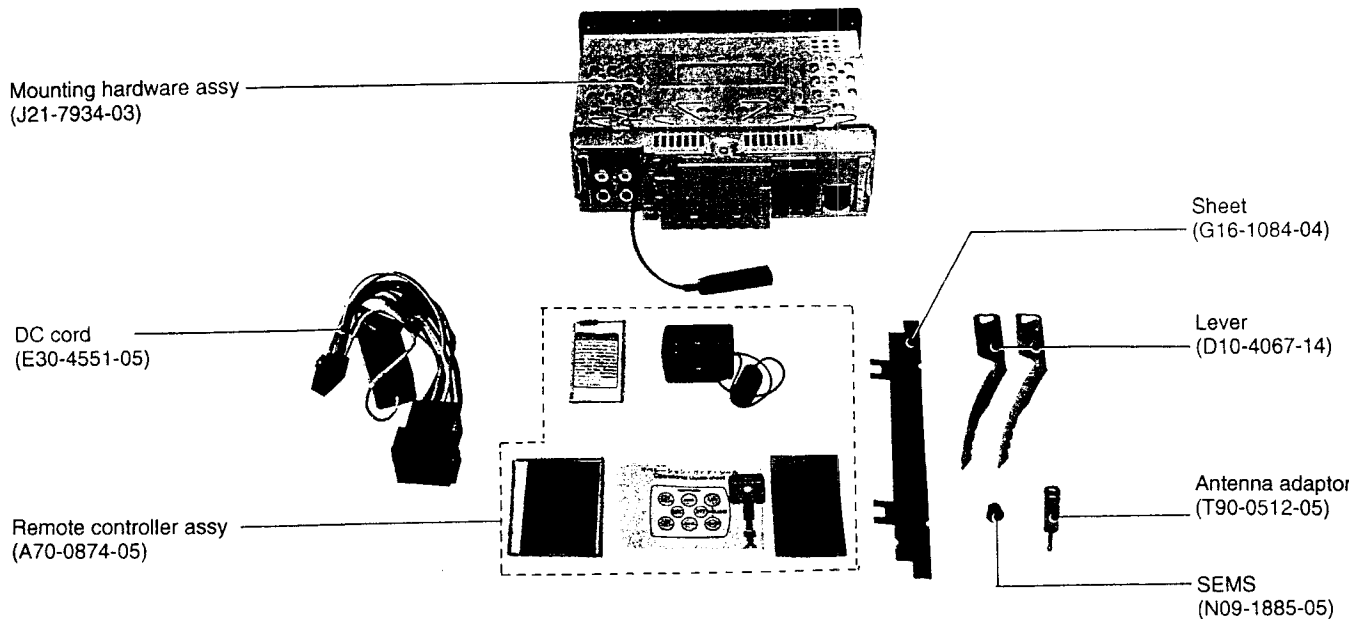
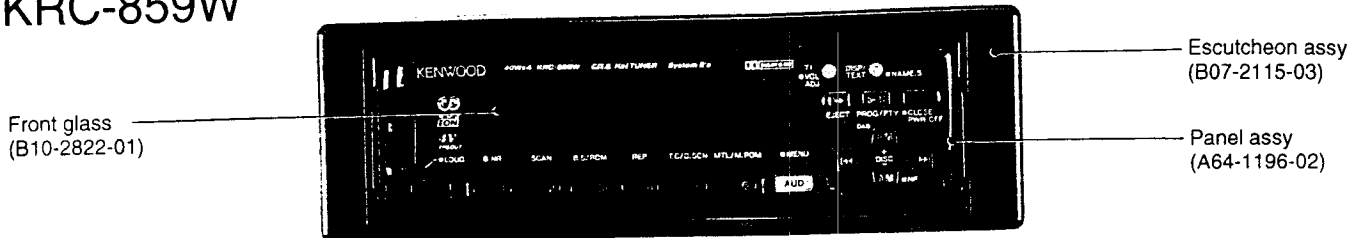

## KRC-759R

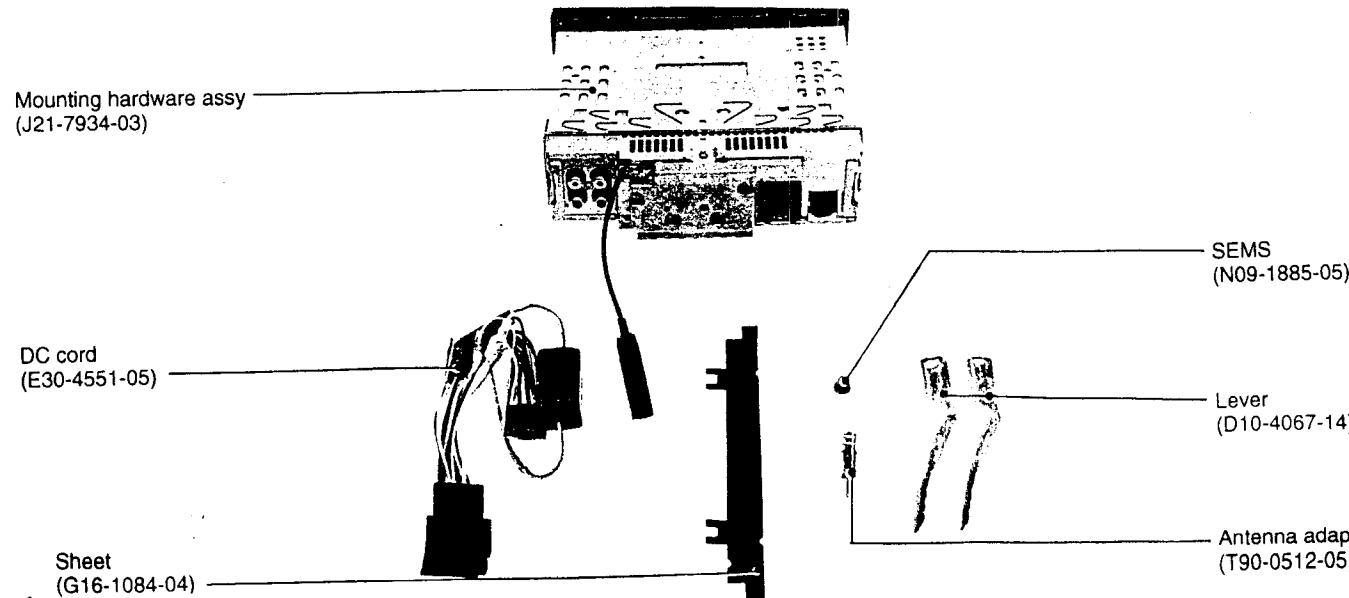
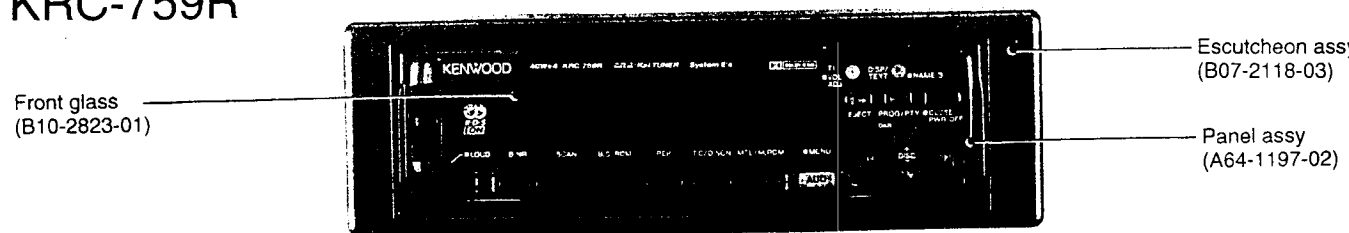

For Service Manuals Contact  
**MAURITRON TECHNICAL SERVICES**  
 8 Cherry Tree Rd, Chirker  
 Oxon OX9 4QV  
 Tel: 01844-351894 Fax: 01844-352554  
 Email: enquiries@mauritron.co.uk

# KRC-705/759R/RV/785/805/859C /CY/R/RV/W/WY/885W/PS955

## KRC-885W

Front glass  
 (D-2818-01)

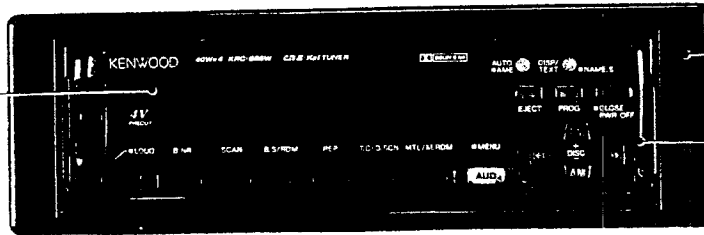

Escutcheon assy  
 (B07-2115-03)

Panel assy  
 (A64-1192-02)

Mounting hardware assy  
 (J-7934-03)

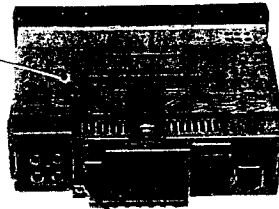

Remote controller  
 (A-1084-04)

Remote controller assy  
 (A70-0860-05)

Escutcheon  
 (B07-2116-02)

Lever  
 (D10-4067-14)

Wiring harness  
 (A-4549-05)

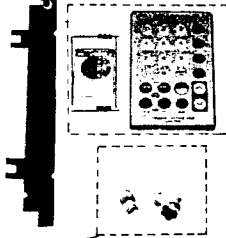

Stay  
 (J54-0606-04)

Bracket set  
 (J-1652-05)

Bracket(R)  
 (J19-4721-04)

Bracket(L)  
 (J19-4720-04)

## KRC-785

Front glass  
 (D-2817-01)

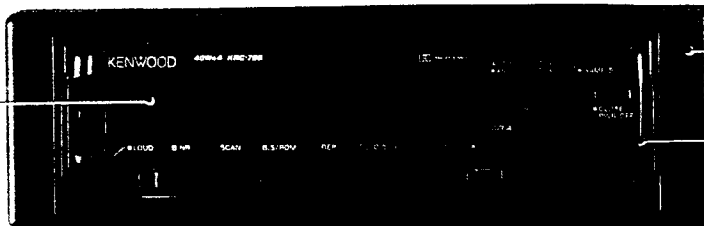

Escutcheon assy  
 (B07-2118-03)

Panel assy  
 (A64-1191-02)

Mounting hardware assy  
 (J-7934-03)

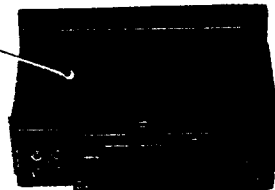

Remote controller  
 (A-1084-04)

Remote controller assy  
 (A70-0860-05)

Escutcheon  
 (B07-2117-02)

Lever  
 (D10-4067-14)

Wiring harness  
 (A-4549-05)

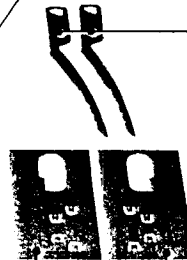
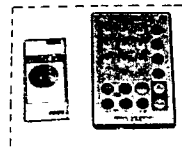

Stay  
 (J54-0606-04)

Bracket set  
 (J-1652-05)

Bracket(R)  
 (J19-4721-04)

Bracket(L)  
 (J19-4720-04)

KRC-705/759R/R/RY/785/805/859C  
/CY/R/R/RY/W/WY/885W/PS955

For Service Manuals Contact  
MAURITRON TECHNICAL SERVICES  
8 Cherry Tree Rd, Chinnor  
Oxon OX9 4QY  
Tel:- 01844-351694 Fax:- 01844-352554  
Email:- enquiries@mauritron.co.uk

## CONTENTS

BLOCK DIAGRAM .....	7	PC BOARD .....	15
COMPONENTS DESCRIPTION .....	8	SCHEMATIC DIAGRAM .....	19
CIRCUIT DESCRIPTION .....	9	EXPLODED VIEW .....	25
ADJUSTMENT .....	13	PARTS LIST .....	27
		SPECIFICATIONS .....	39

## MEMO

# KRC-705/759R/RV/785/805/859C /CY/R/RV/W/WY/885W/PS955

## BLOCK DIAGRAM

For Service Manuals Contact  
 TECHNICAL SERVICES  
 9 Chervy Tree Rd, Chinnor  
 Oxon OX9 4QY  
 Tel: 01295 81894 Fax: 01844 352554  
 Email: enquiries@mauntron.co.uk

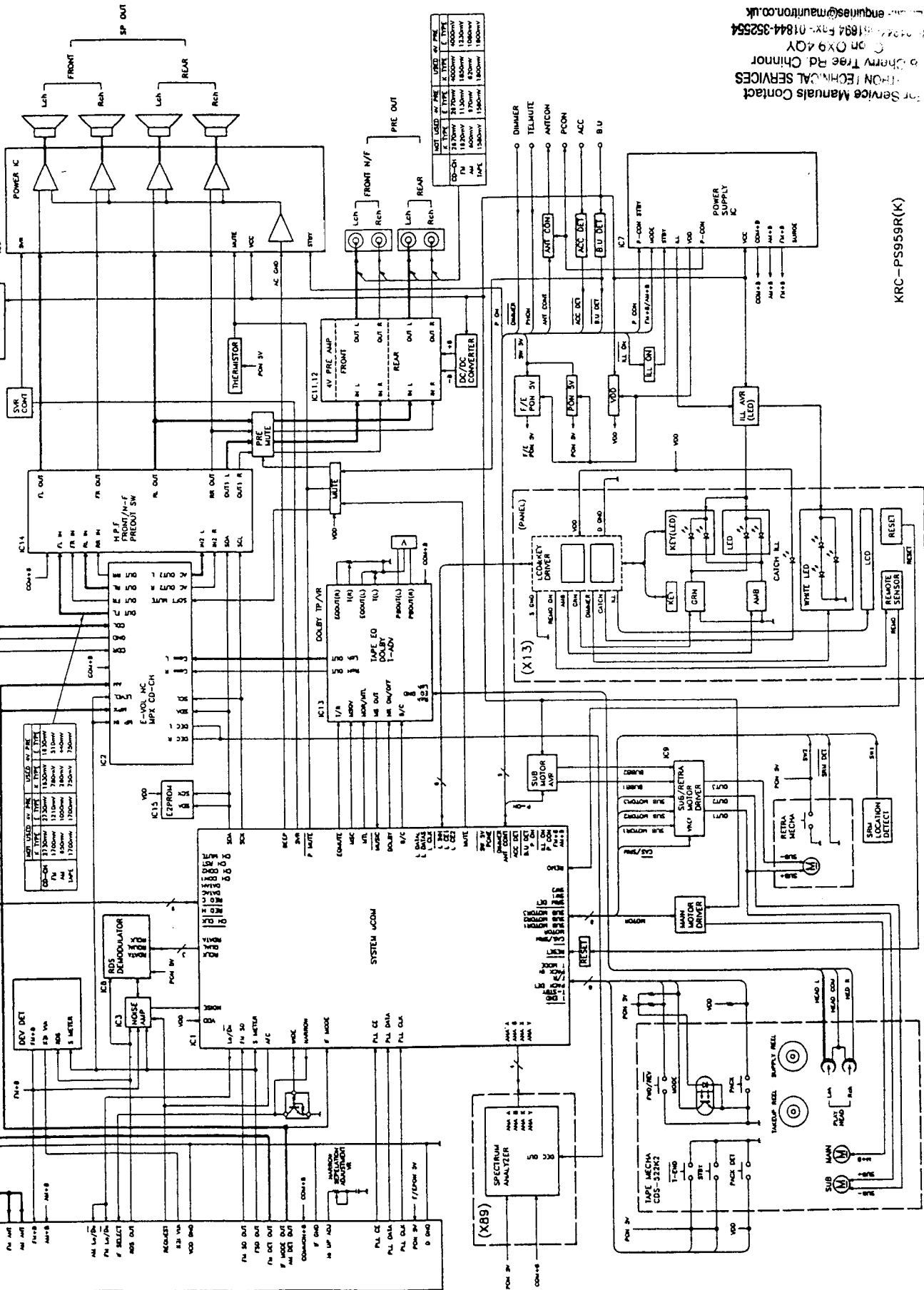

KRC-PS959R(K)

KRC-705/759R/R/785/805/859C  
/CY/R/R/RY/W/WY/885W/PS955

For Service Manuals Contact  
MAURITON TECHNICAL SERVICES  
8 Cherry Tree Rd, Chinnor  
Oxon OX9 4QY  
Tel: 01844-351694 Fax: 01844-352554  
Email: enquiries@mauriton.co.uk

## COMPONENTS DESCRIPTION

### SYNTHESIZER UNIT(X14-568X-XX)

Element	Application/Function	Operation/Conditions/Compatibility
IC1	Microprocessor system control	
IC2	E-VOL, NC, MPX	
IC3	Noise amplifier	
IC6	Power IC	
IC7	Power IC	
IC8	R.D.S. decoder	
IC9	C mechanism and housing mechanism sub-motor driver	
IC10	DC/DC converter	
IC11, 12	4V op amp	
IC13	T-EQ, T-ADV, Dolby	
IC14	H.P.F. selection, N/F selection	
IC15	EPROM	
IC16	Mute logic circuit	
IC18	DEV DET converter	
IC20	Reset IC	
Q1, 2, 3, 4	Pre-out mute	Mute at base "H".
Q10, 11	Music sensor detection constant selection	Base "H" during tape playback, base "L" in modes other than FF tape.
Q90	E-VOL IC mute	Mute at base "H".
Q121	Noise buffer	
Q122, 123	Noise detection output constant selection	Q123 base "L" during seek, "H" during reception.
Q139	Overmodulation detection	Base "H" during overmodulation.
Q140	Overmodulation detection	Base "H" during overmodulation.
Q141	Weak electric field	Base "L" when electric field is weak.
Q151	Sub-motor voltage switching	C mechanism voltage at base "L", SRM mechanism voltage at base "H".
Q199	SVR switch	Mute at base "H".
Q202, 204	P-ANT switch	P-ANT on at Q209 base "H".
Q205	Backup detection	Backup detection at base "H".
Q206	ACC detection	Acc detection at base "H".
Q207	B.V 5V AVR	5V on at base "H".
Q208	Pre-mute switch	Pre-mute on at base "L".
Q209	P-ON V5 AVR	On at base "L".
Q210	F/E P-ON 5V AVR	On at base "L".
Q211	Dimmer switch	Dimmer at base "H".
Q231	CH2 control switch	CH2 on at base "L".
Q241, 242	4V op amp 10V AVR	On at base "H".
Q243, 244	10V AVR switch	On at base "H".
Q245 - 250	Plus-minus differential stabilizing circuit	
Q301, 302	Main motor AVR	AVR on at Q302 base "H".
Q303, Q305	LED AVR	AVR on at Q305 base "H".
Q304, Q307	Sub-motor driver AVR	AVR on at Q307 base "H".
Q306, Q308	Sub-motor driver AVR switch	AVR on at Q308 base "H".
Q311	Reset switch	Reset at base "H".
Q323	FM LO/DX switch	DX at base "H", LO at base "L".
Q324	Forced wide switch	Base "H" at forced wide.



For Service Manuals Contact  
 MAURITRON CONTACTS  
 MAURITRON TECHNICAL SERVICES  
 8 Chisley Tree Rd, Chingford,  
 Essex OX9 4QY, Essex  
 Tel: 01444 951894 Fax: 01444 360554  
 Email: enquiries@mauratron.co.uk

KRC-705/759R/RV/785/805/859C  
 /CY/R/RV/W/WY/885W/PS955

## CIRCUIT DESCRIPTION

### 01: UPD784215GF522 (X14-568X-XX) Microcomputer

#### Terminal descriptions

Pin	Pin Name	Name	I/O	Function	Description
1	P60/A16	TYPE0	I	Destination pin 0	
2	P61/A17	TYPE1	I	Destination pin 1	
3	P62/A18	TYPE2	I	Destination pin 2	
4	P63/A19	ST_TYPE0	I	IC2 Ver. 2 destination pin 0	Default : Lo
5	P64/RD	ST_TYPE1	I	IC2 Ver. 2 destination pin 1	Default : Lo
6	P65/WR	NC	O	Output open	
7	P66/WAIT	ANA_B	O	Spectrum analyzer frequency selection pin	
8	P67/ASTB	ANA_A	O	Spectrum analyzer frequency selection pin	
9	Vdd		-	Positive power supply pin	
10	P100/TI5/TO5	NC	O	Output open	
11	P101/TI6/TO6	SVR	O	Power IC reset pin : Power on : Lo	
12	P102/TI7/TO7	NC	O	Output open	
13	P103/TI8/TO8	P_MUTE	O	Power IC mute pin	Active : Hi
14	P30/TO0	ANT_CON	O	Antenna control pin	Active : Hi
15	P31/TO1	FM+B	O	FM power supply pin	Active : Hi
16	P32/TO2	AM+B	O	AM power supply pin	Active : Hi
17	P33/TI1	P_CON	O	Power control pin	Active : Hi
18	P34/TI2	ACC_DET	I	ACC detection pin	ACC off: Hi
19	P35/TI00	REMO	I	Remote control input pin	
20	P36/TI01	P_ON	O	Microprocessor peripheral power supply pin	Active : Hi
21	P37	BU_DET	I	Mute detection pin	Mute : Hi
22	TEST		-	Test pin	
23	P90	IC2_SDA	I/O	IC2, IC5, EEPROM data line	
24	P91	IC2_SCK	O	IC2, IC5, EEPROM clock line	
25	P92	MUTE	O	Mute pin	Active : Hi
26	P93	SW5	O	5V power supply pin	Active : Lo
27	P94	ILL_ON	O	Illumination output pin	Active : Hi
28	P95	CHCON2	O	Changer 2 control pin	Active : Lo
29	P120/RTP0	CHCON1	O	Changer 1 control pin	Active : Hi
30	P121/RTP1	CH_MUTE	I	Changer mute input pin	Mute request : Hi
31	P122/RTP2	REQH	O	Changer handshake request pin	Active : Lo
32	P123/RTP3	DIMMER	I	Small detection pin	Active : Lo
33	P124/RTP4	MOTOR	O	C mechanism main motor output pin	Active : Hi
34	P125/RTP5	T_END	I	Tape end detection pin	Normal playback : Hi
35	P126/RTP6	T_STBY	I	C mechanism standby input pin	
36	P127/RTP7	PACK_DET	I	Pack detection pin	Pack detected : Hi

# KRC-705/759R/RV/785/805/859C /CY/R/RV/W/WY/885W/PS955

For Service Manuals Contact  
MAURITRON TECHNICAL SERVICES  
8 Cherry Tree Rd, Chinnor  
Oxon OX9 4QY  
Tel: 01844-351694 Fax: 01844-352554  
Email: enquiries@mauritron.co.uk

## CIRCUIT DESCRIPTION

### Terminal descriptions

Pin	Pin Name	Name	I/O	Function	Description
37	Vdd		-	Positive power supply pin	
38	X2		-	Main clock connection pin	
39	X1		-	Main clock connection pin	
40	Vss		-	GND pin	
41	XT2		-	Sub clock connection pin	
42	XT1		-	Sub clock connection pin	
43	RESET		I	Reset input pin	Active : Lo
44	P00/INTP0	CH_RST	O	Changer reset output pin	Active : Hi
45	P01/INTP1	R_CLK	I	RDS clock input pin	
46	P02/INTP2/NMI	REQC	I	Changer handshake request pin	Active : Lo
47	P03/INTP3	CAS/SRM	O	C mechanism/SRM mechanism voltage selection pin.	C mechanism : Lo, SRM mechanism : Hi
48	P04/INTP4	SUB_MOTOR1	O	Sub-motor output pin	
49	P05/INTP5	SUB_MOTOR2	O	Sub-motor output pin	
50	P06/INTP6	SUB_MOTOR3	O	Sub-motor output pin	
51	AVdd		-	A/D analog power supply pin	
52	AVref0		-	A/D reference voltage input pin	
53	P10/ANI0	PHONE	I	PHONE detection pin.	1V or less : PHONE, 2.5V or greater : NAVI MUTE
54	P11/ANI1	SRM_SW1	I	SRM position detection pin.	Open : Hi
55	P12/ANI2	NOISE	I	FM noise detection pin	
56	P13/ANI3	SMETER	I	FM S meter detection pin	
57	P14/ANI4	ANA_X	I	Spectrum analyzer input pin	
58	P15/ANI5	ANA_Y	I	Spectrum analyzer input pin	
59	P16/ANI6	IF_MODE	I	K21 IF mode detection pin.	Wide : Hi, Narrow : Lo
60	P17/ANI7	T_MODE	I	C mechanism mode detection pin	
61	AVss		-	A/D GND pin	
62	P130/ANO0	NC	O	Output open	
63	P131/ANO1	NC	O	Output open	
64	AVref1		-	D/A reference voltage input pin	
65	P70/RxD2/SI2	DATA_C	I	Data line from changer	
66	P71/TxD2/SO2	DATA_H	O	Data line to changer	
67	P72/ASCK2	CH_CLK	I/O	Changer clock line	
68	P20/RxD1/SI1	L_DATA_L	I	Data line to LCD driver	
69	P21/TxD1/SO1	L_DATA_S	O	Data line to LCD driver	
70	P22/ASCK1	L_CLK	O	LCD driver clock pin	
71	P23/PCL	NC	O	Output open	
72	P24/BUZ	BEEP	O	Beep detection pin	Active : Hi
73	P25/SI0	PLL_CE	O	PLL CE pin	
74	P26/SO0	PLL_DATA	I/O	PLL data input/output pin	

## CIRCUIT DESCRIPTION

### Terminal descriptions

Pin	Pin Name	Name	I/O	Function	Description
75	P27/SCK0	PLL_CLK	O	PLL clock pin	
76	P80/A0	PACK_IN	I	Pack in detection pin	Pack in : Hi
77	P81/A1	F/R	I	C mechanism FWD/REV detection pin	FWD : Hi, REV : Lo
78	P82/A2	WIDE	O	K2I forced wide output pin	Active : Hi
79	P83/A3	NARROW	O	K2I forced narrow output pin	Active : Hi
80	P84/A4	KEY_REQ	I	Key input request from LCD driver	Key : Hi
81	P85/A5	L_CE1	O	LCD driver CE pin	
82	P86/A6	L_INH	O	LCD driver reset pin	Reset : Lo
83	P87/A7	L_CE2	O	LCD driver CE pin	
84	P40/AD0	QUAL	I	RDS reception mode	
85	P41/AD1	R_DATA	I	RDS data input pin	
86	P42/AD2	NC	O	Output open	
87	P43/AD3	NC	O	Output open	
88	P44/AD4	SRM_DET	I	SRM mechanism detection pin	Mechanism : L , No mechanism : Hi
89	P45/AD5	SRM_SW2	I	SRM eject position detection pin	Startup : Eject position
90	P46/AD6	FM_SD	I	FM SD input pin	Station : Hi, No station : Lo
91	P47/AD7	NC	O	Output open	
92	P50/A8	AFC	O	Noise detection constant selection pin	Reception : Hi, Search : Lo
93	P51/A9	LO/DX	O	Local output pin	Local : Hi, Normal : Lo
94	P52/A10	MUSIC	I	Tape selection detection pin	Selection : Lo : No selection : Hi
95	P53/A11	MSC	O	Blank detection constant selection pin	Play mode : Hi, FF/REW mode : Lo
96	P54/A12	MTL	O	Metal output pin	Active : Hi
97	P55/A13	EQ_MUTE	O	EQ mute output pin	Active : Hi
98	P56/A14	DOLBY	O	Dolby output pin	Active : Hi
99	P57/A15	B/C	O	Dolby B/C selection pin	B : Lo, C : Hi
100	Vss		-	GND pin	

### TEST MODE

To enter test mode

While holding the "FM" key and preset "6" key, reset the unit.  
 All indication segments are ON at the beginning of test mode.

To release test mode

Simply reset the unit.

(NOTE) The test mode is not canceled by ACC OFF, power OFF, momentary power down or the panel detaching.

FM signal meter voltage adjustment

- 1) Enter test mode .
- 2) Receive 98.1MHz with the SG and set the ANT input level to 35dBf $\hat{E}$ . The modulation should be off during this.

# KRC-705/759R/R/RY/785/805/859C /CY/R/R/RY/W/WY/885W/PS955

## CIRCUIT DESCRIPTION

For Service Manuals Contact  
MAURITRON TECHNICAL SERVICES  
8 Cherry Tree Rd, Chinnor  
Oxon OX9 4QY  
Tel:- 01844-351694 Fax:- 01844-352554  
Email:- enquiries@mauritron.co.uk

- 3) While holding preset "1" key, press and hold preset "6" key for a few seconds.
- 4) "ADJ OK" is displayed if the adjustment is OK and "ADJ NG" is displayed if it is not good.

#### 4. AM SD voltage writing

- 1) Enter test mode.
- 2) Receive 999kHz or 1000kHz with the SG and set the ANT input level to 35dBf. The modulation should be off during this.
- 3) While holding preset "1" key, press and hold preset "6" key for a few seconds to write the SD voltage.

#### 5. K2I AUTO/MANUAL switching

Hold down the "TI" key for 2 second to switch K2I between AUTO and MANUAL.  
The initial mode is MANUAL, with which the "TEXT" dot lights up.

#### 6. K2I Forced Narrow/Wide switching

Press preset "6" key to switch K2I between forced Narrow and Wide.  
The initial mode is Wide, with which the "NR" dot lights up.

#### 7. Audio adjustments

The volume is set to -10dB (which is shown as 30).  
The BASS/TREBLE and BALANCE/FADER controls can be set to the full boost / full cut and full front / full rear respectively by pressing the "UP"/"DOWN" keys.  
The high pass filter can be set to 220Hz/ Through by pressing the "UP"/"DOWN" keys.  
Note that, however, the non-fader control is varied in +1dB/-1dB steps by pressing the "UP"/"DOWN" keys.

#### 8. Changing the E2PROM for servicing (for E/M type SRMs only)

- 1) Set the test mode. (Refer to "1 Setting the test mode".)
- 2) Press the "SRC" key and select TUNER.
- 3) Press the "AUDIO" key for at least 1 second to enter the menu mode.
- 4) Press the seek up or seek down key and select "SECURITY".
- 5) Press the "FM" or "AM" key for at least 2 seconds.
- 6) Press the "1", "2", "3" and "4" keys to input the code.  
Example - To input "3510":
  - Press the "1" four times.
  - Press the "2" six times.
  - Press the "3" two times.
  - Press the "4" one time.
- 7) Press the "DISP" key for 3 seconds to display "APPROVED".
- 8) Cancel the test mode. (Refer to "2 Canceling the test mode".)

#### 9. Simple security code clear during servicing (for K type SRMs only)

- 1) When the code is requested, press the VOL UP key for at least 3 seconds while press the "DISP" key. ("----" turns off.)
- 2) Input "KCAR" from the remote control unit (as for '97 models).
  - Press the "5" key two times, then press the seek up key. ("K" is input.)
  - Press the "2" key three times, then press the seek up key. ("C" is input.)
  - Press the "2" key one time, then press the seek up key. ("A" is input.)
  - Press the "7" key two times, then press the seek up key. ("R" is input.)
- 3) The security mode is cleared and the tuner mode is set.



KRC-705/759R/R/RY/785/805/859C  
/CY/R/R/RY/W/WY/885W/PS955

For Service Manuals Contact  
MAURITRON TECHNICAL SERVICES  
8 Cherry Tree Rd, Chinnor  
Oxon OX9 4QY  
Tel: 01844-351884 Fax: 01844-352554  
Email: enquires@mauritron.co.uk

# ADJUSTMENT

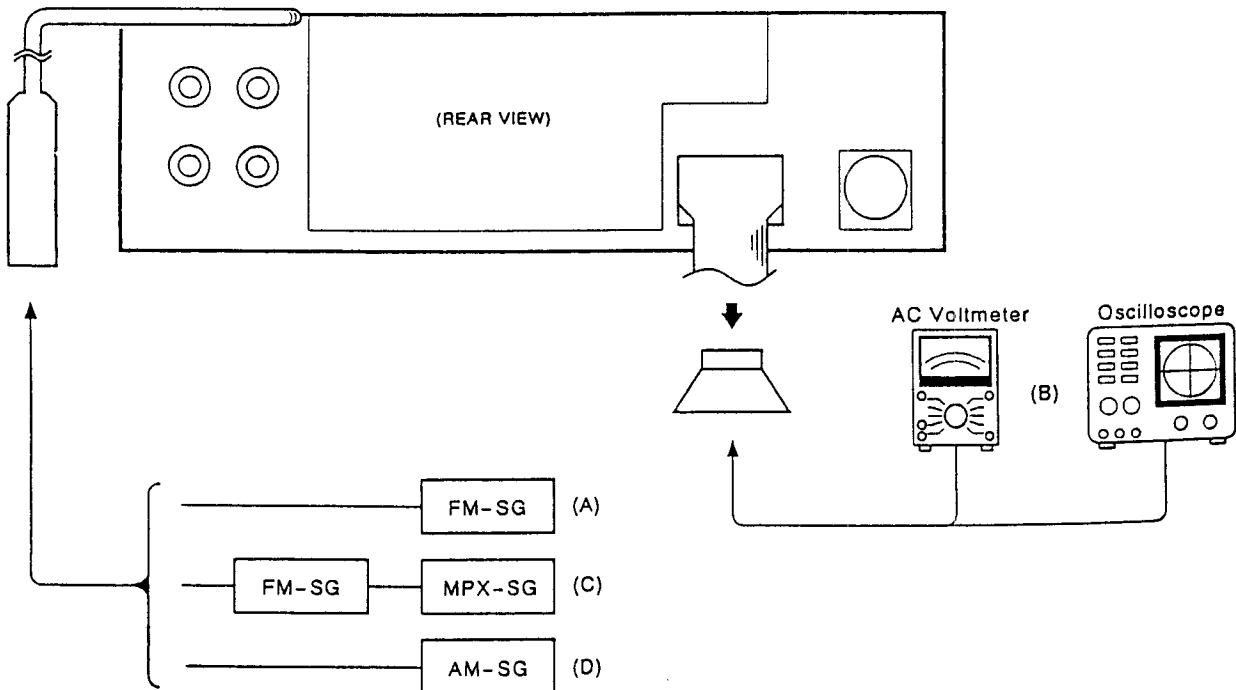
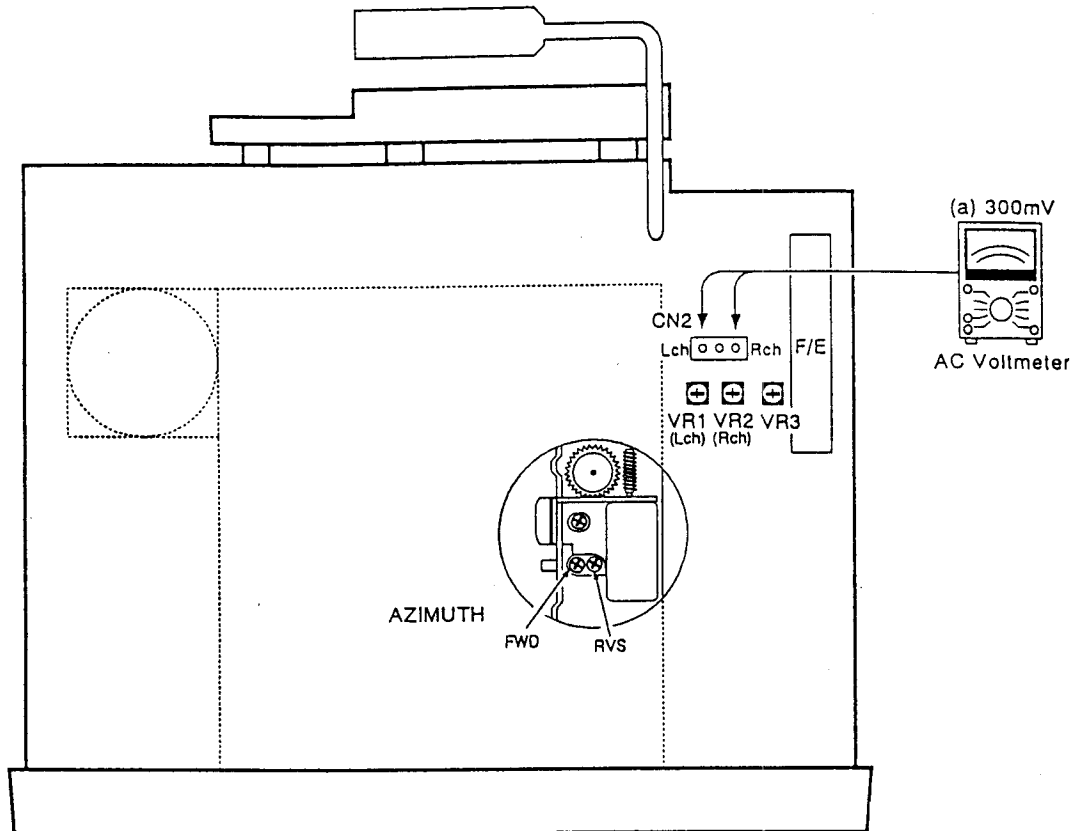

2

3

4

5

6

7

# PC BOARD (Component side view)

SYNTHESIZER UNIT  
(X14-568X-XX)

Ref. No.		Address
IC	Q	
1		6C
2		5D
3		6E
6		3D
7		5B
8		6D
9		7E
10		4D
11		4E
12		4E
13		6E
14		4D
15		5C

Ref. No.		Address
IC	Q	
16		5C
18		5F
20		7B
1		4E
2		4E
3		5E
4		5E
10		6D
11		6D
90		5D
121		6E
122		6D
123		6D

Ref. No.		Address
IC	Q	
139		5F
140		5F
141		5F
151		7E
199		4D
202		5C
204		5C
205		5B
206		5C
207		6A
208		5C
209		5A
210		7C

Ref. No.		Address
IC	Q	
211		4B
231		6B
241		4C
242		4D
243		4C
244		5C
245		4C
246		4D
247		4D
248		4D
249		4D
250		4D
301		6B

For Service Manual Contact  
MAURITRON TECHNICAL SERVICES  
8 Cherry Tree Rd, Chinnor  
Oxon OX9 4QY  
Tel: 01844-351694 Fax: 01844-352554  
Email: enquiries@mauritron.co.uk

Ref. No.		Address
IC	Q	
		302 5B
		303 6A
		304 7B
		305 6A
		306 7B
		307 7B
		308 7B
		311 7B
		323 4F
		324 6C

## SYNTHESIZER UNIT (X14-568X-XX)

X14-568X-XX  
(J74-0699-12)

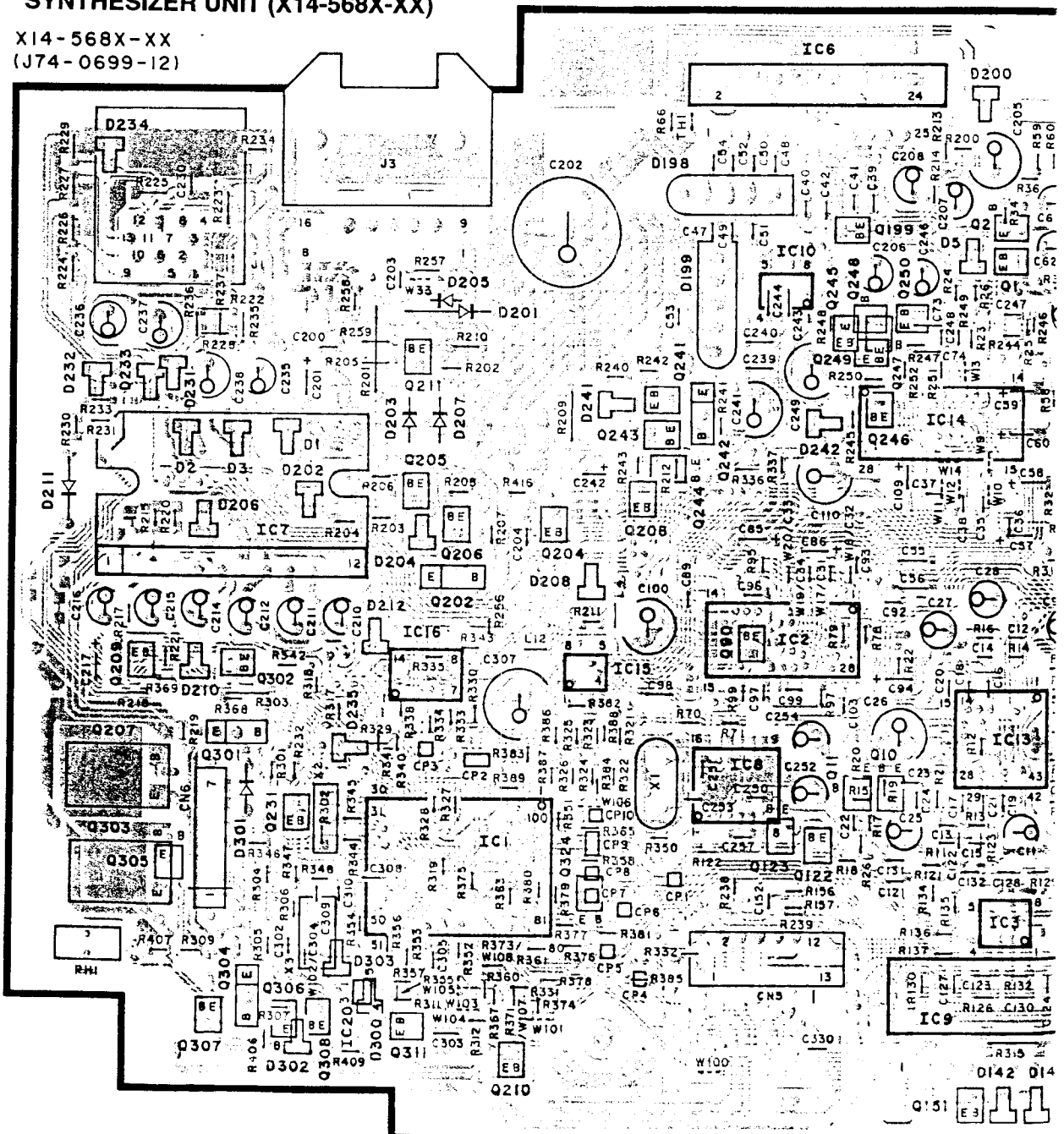

(side view)

Ref. No.	Address
IC 139	5F
140	5F
141	5F
151	7E
199	4D
202	5C
204	5C
205	5B
206	5C
207	6A
208	5C
209	5A
210	7C

Ref. No.	Address
IC 211	4B
231	6B
241	4C
242	4D
243	4C
244	5C
245	4C
246	4D
247	4D
248	4D
249	4D
250	4D
301	6B

Ref. No.	Address
IC 302	5B
303	6A
304	7B
305	6A
306	7B
307	7B
308	7B
311	7B
323	4F
324	6C

For Service Manuals Contact  
**MAURITRON TECHNICAL SERVICES**  
 8 Cherry Tree Rd, Chinnor  
 Oxon OX9 4QY  
 Tel:- 01844-351694 Fax:- 01844-352554  
 Email:- enquiries@mauritron.co.uk

SWITCH (X13-91)

Ref. No.
IC 1
2
3

(XX)

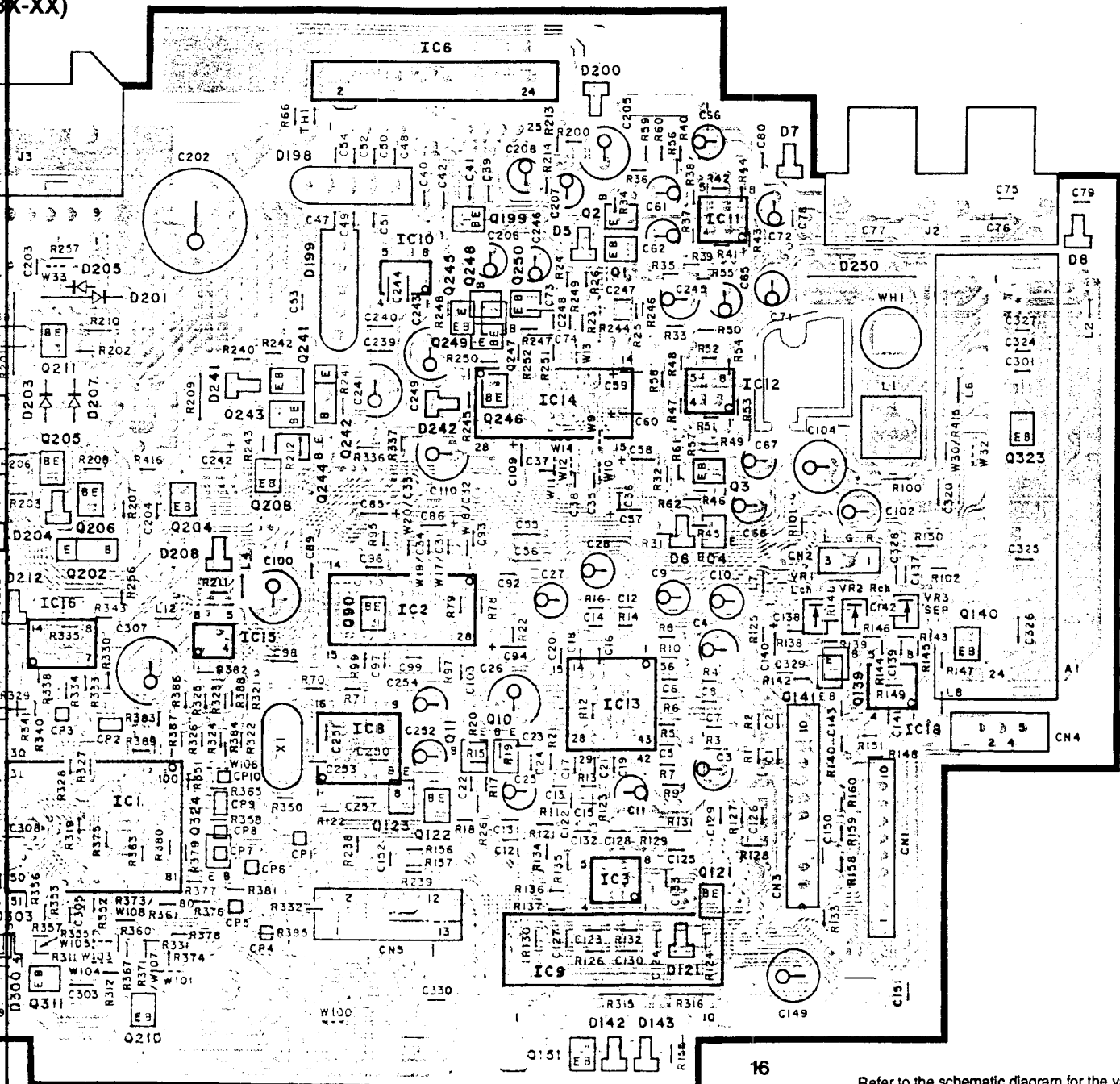



For Service Manuals Contact  
**MAURITRON TECHNICAL SERVICES**  
 8 Cherry Tree Rd: Chinnor  
 Tel: 01844 351694 Fax: 01844 352554  
 Email: enquiries@maurtron.co.uk

### SWITCH UNIT (X13-9140-10)

X13-9140-10 (J74-0718-02)

SWITCH UNIT  
(X13-9140-10)

Ref. No.		Address
IC	Q	
1		3H
2		6H
3		7H
	1	3I
	2	6H
	3	5I
	4	5I
	5	2H
	6	6H

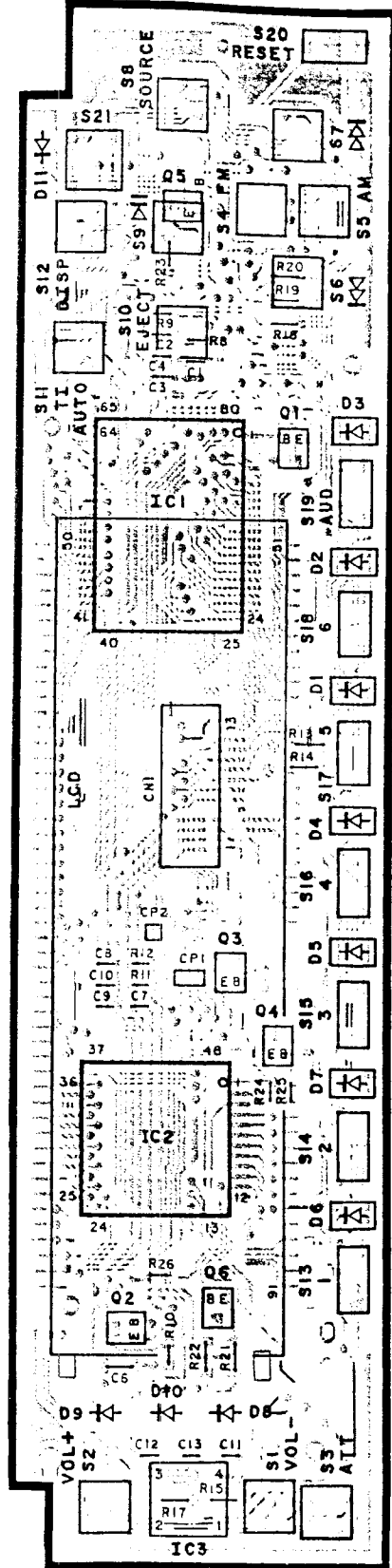
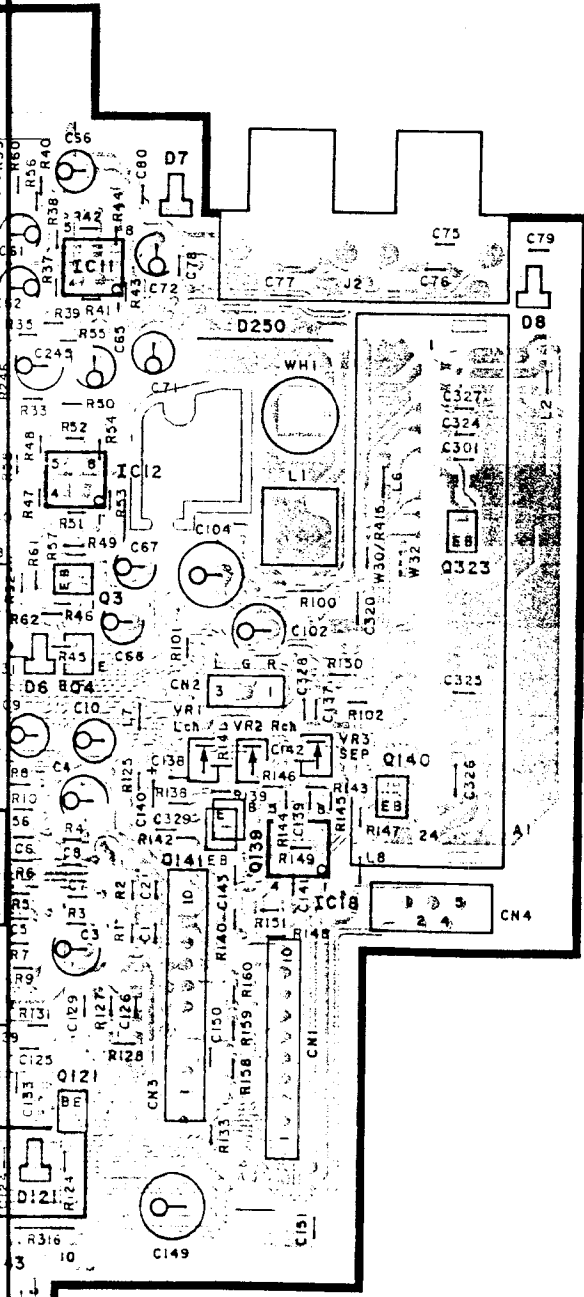

**SWITCH UNIT (X13-9140-10)**  
X13-9140-10 (J74-0718-02)

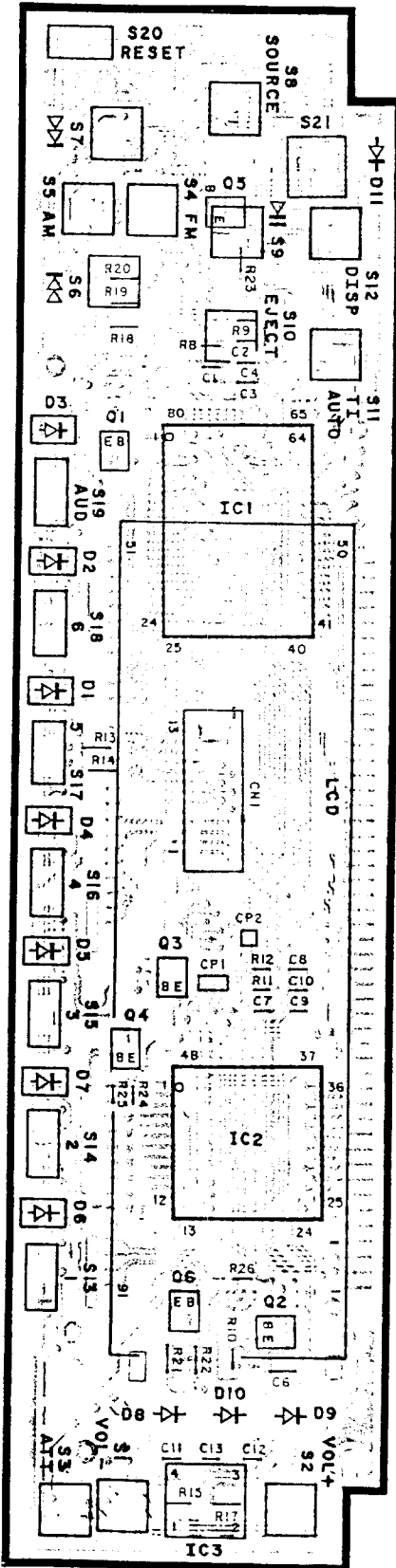

**SWITCH UNIT (X13-9140-10)**

Ref. No.	IC	Q	Address
1			3K
2			6K
3			7K
	1		3J
	2		6K
	3		5J
	4		5J
	5		2K
	6		6J

Service Manuals Centre  
**MAURITRON TECHNICAL SERVICES**  
 8 Cherry Tree Road, Chinnor  
 Oxon OX9 4QV  
 Tel: 01844-351694 Fax: 01844-352554  
 Email: enquiries@mauritron.co.uk

For MAU 8C  
 Tel: 01844  
 Email: enquiries@mauritron.co.uk

**SYNTHESIZER UNIT (X14-568X-XX)**

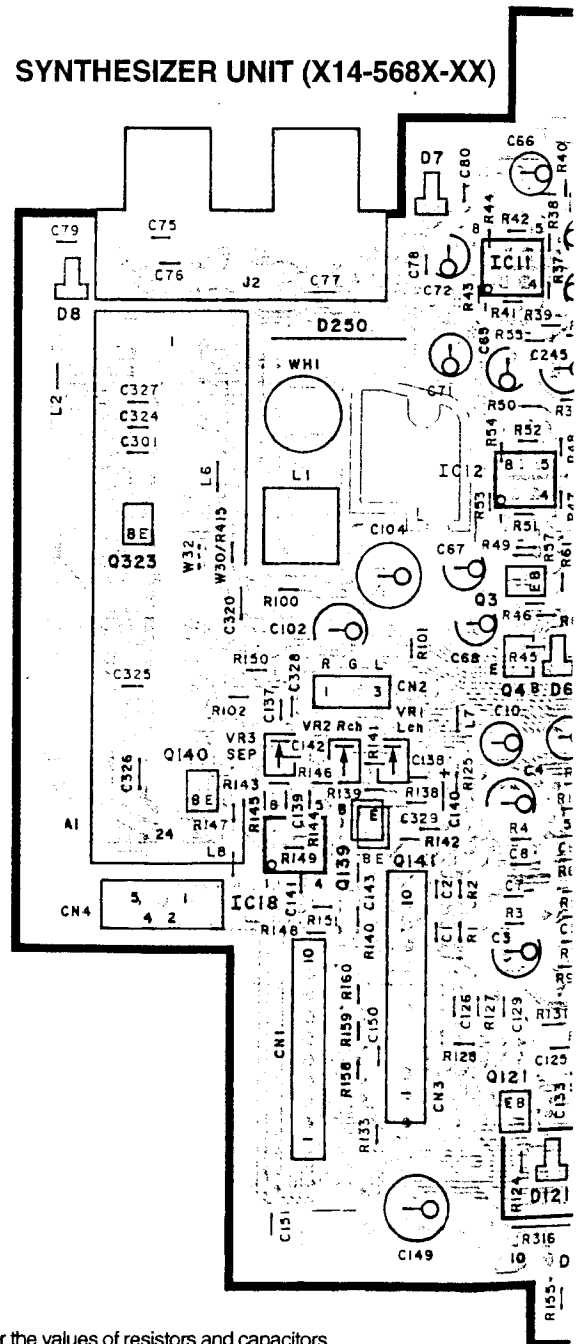

Refer to the schematic diagram for the values of resistors and capacitors.

**SYNTHESIZER UNIT  
(X14-568X-XX)**

Ref. No.		Address	Ref. No.		Ac
IC	Q		IC	Q	
1		6P	16		
2		5O	18		
3		6N	20		
6		3O		1	
7		5Q		2	
8		6O		3	
9		7N		4	
10		4O		10	
11		4N		11	
12		4N		90	
13		6N		121	
14		4N		122	
15		5P		123	

For Service Manuals Contact  
**MAURITRON** Technical Service  
 8 Cherry Tree Rd. Chinn  
 Oxon OX9 4DQ  
 Tel: 01844-351400  
 Email: enquiries@mauritr.com

**SWITCH UNIT  
(X13-9140-10)**

Ref. No.		Address
IC	Q	
1		3K
2		6K
3		7K
	1	3J
	2	6K
	3	5J
	4	5J
	5	2K
	6	6J

**X14-568X-XX (J74-0699-12)**

**SYNTHESIZER UNIT (X14-568X-XX)**

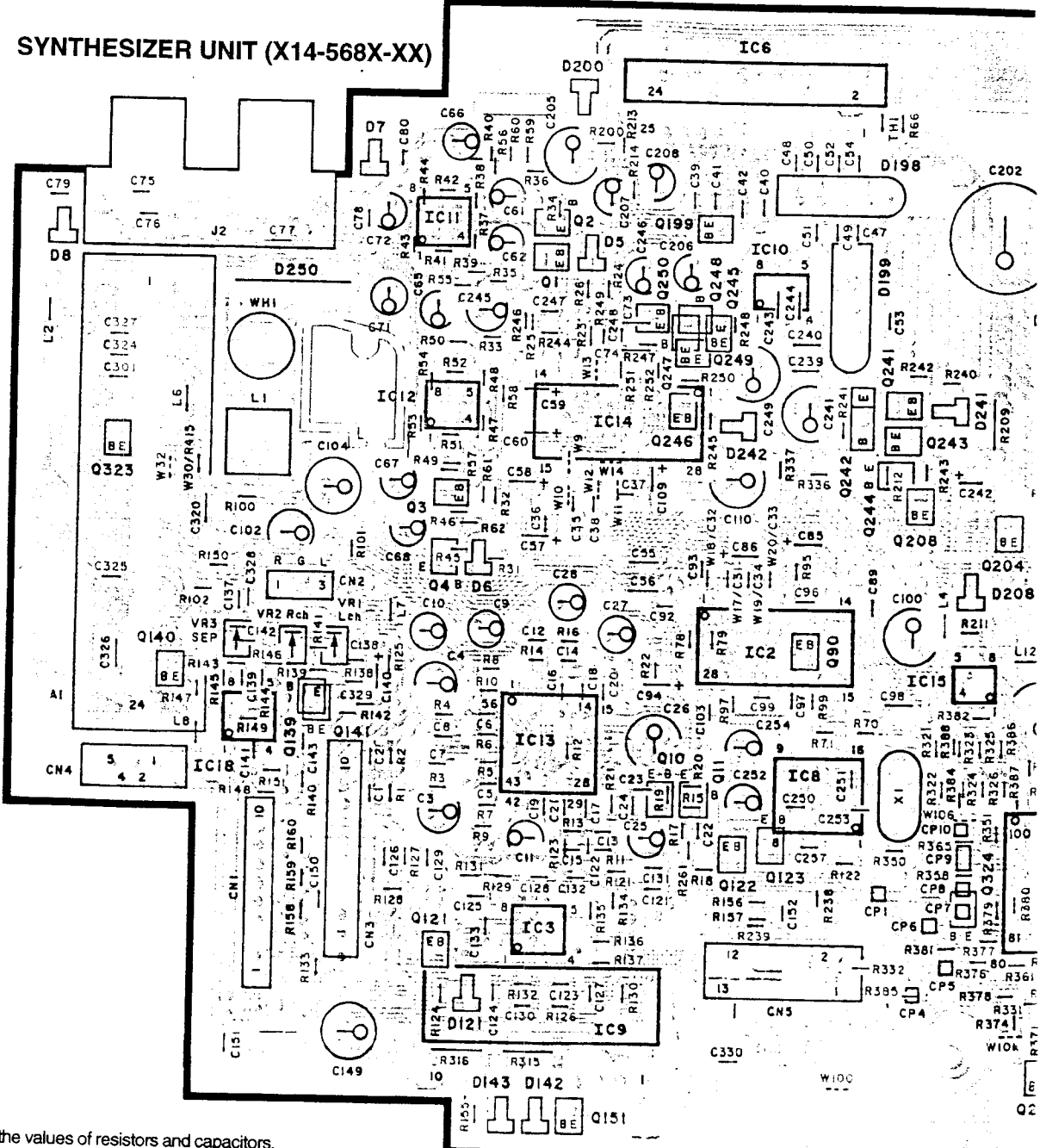

Refer to the schematic diagram for the values of resistors and capacitors.

# PC BOARD (Foil side view)

## SYNTHESIZER UNIT (X14-568X-XX)

For Service Manuals Contact  
**MAURITRON TECHNICAL SERVICES**  
 8 Cherry Tree Rd, Chinnor  
 Oxon OX9 4QY  
 Tel: 01844-351694 Fax: 01844-352554  
 Email: enquiries@mauritron.co.uk

Ref. No.		Address
IC	Q	
1		6P
2		5O
3		6N
6		3O
7		5Q
8		6O
9		7N
10		4O
11		4N
12		4N
13		6N
14		4N
15		5P

Ref. No.		Address
IC	Q	
16		5P
18		5M
20		7Q
	1	4N
	2	4N
	3	5N
	4	5N
	10	6O
	11	6O
	90	5O
	121	6N
	122	6O
	123	6O

Ref. No.		Address
IC	Q	
	139	5M
	140	5M
	141	5M
	151	7N
	199	4O
	202	5P
	204	5P
	205	5Q
	206	5P
	207	6R
	208	5P
	209	5R
	210	7P

Ref. No.		Address
IC	Q	
	211	4Q
	231	6Q
	241	4P
	242	4O
	243	4P
	244	5P
	245	4O
	246	4O
	247	4O
	249	4O
	250	4O
	301	6Q

Ref. No.		Address
IC	Q	
	302	5Q
	303	6R
	304	7Q
	305	6R
	306	7Q
	307	7Q
	308	7Q
	311	7Q
	323	4M
	324	6P

X14-568X-XX (J74-0699-12)

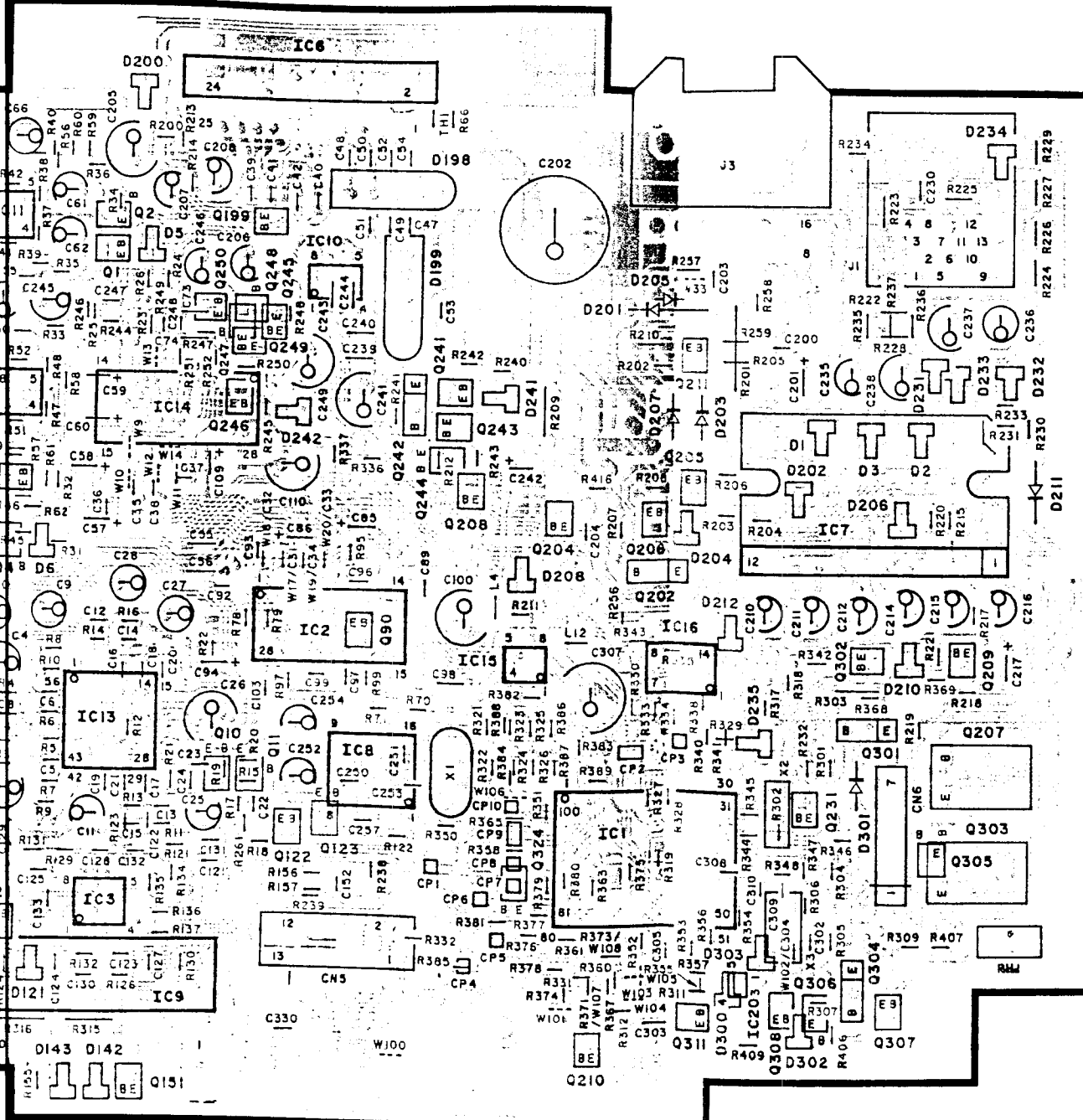

1  
2  
3  
4  
5  
6  
7

A

B

C

D

E

1

2

3

4

5

6

For Service Manuals Contact  
**MAURITRON TECHNICAL SERVICES**  
 8 Cherry Tree Rd, Chimbor  
 Oxon OX9 4QY  
 Tel: 01844-351694 Fax: 01844-352554  
 Email: enquiries@maurtron.co.uk

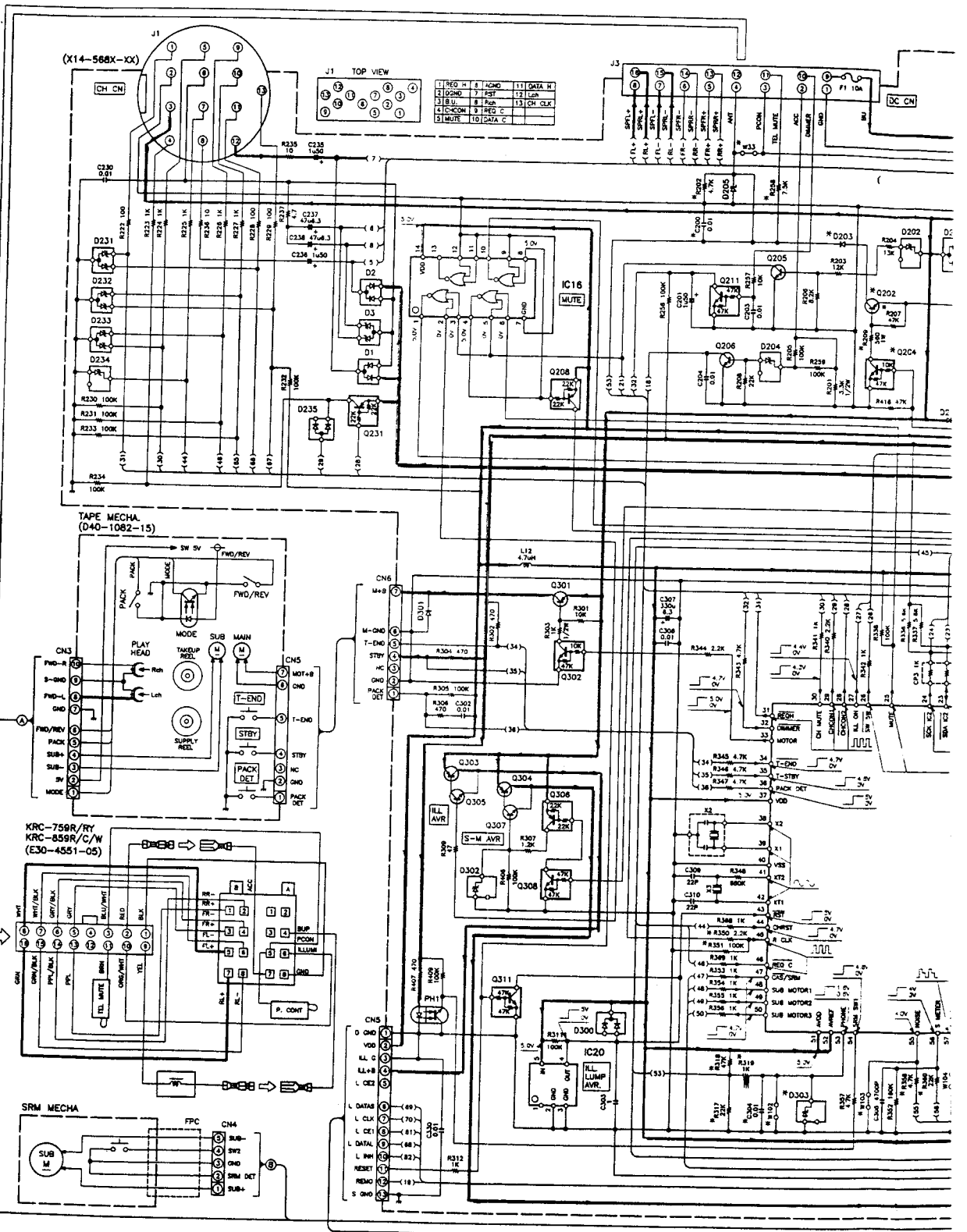

DTA114EK  
 DTA114YK  
 DTA124EK  
 DTA144EK  
 DTC114TK  
 DTC114YK  
 DTC124EK  
 DTC124TK  
 DTC143TK

DTC144EK  
 DTD123YK  
 2SC2412K  
 2SD2114K

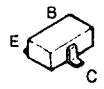

2SB1184

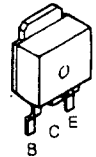

2SB1277  
 2SB1443

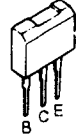

2SA1037K

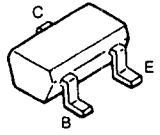

BA6238A

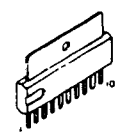

NJM2903M  
 NJM4565M-TE2

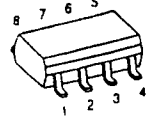

DAN202

A2

For Service Manuals Contact  
**MAURITRON TECHNICAL SERVICES**  
 8 Cherry Tree Rd, Chinnor  
 Oxon OX9 4OY  
 Tel: 01844-351894 Fax: 01844-352554  
 Email: enquiries@mauritron.co.uk

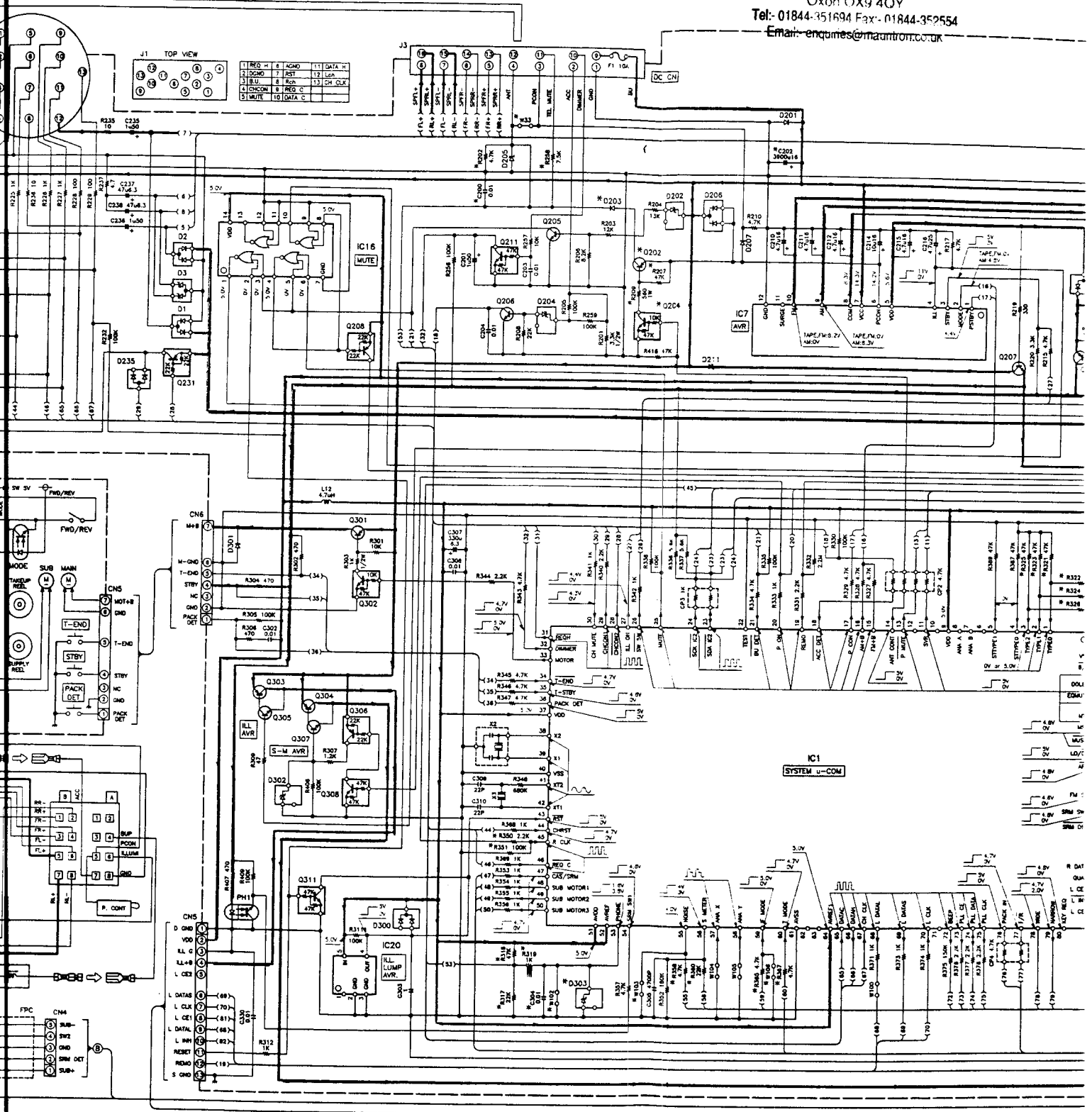

2SB1277  
2SB1443

2SA1037K

BA6238A

NJM2903M  
NJM4565M-TE2

DAN202K

DA204K

RD6.8M

TC

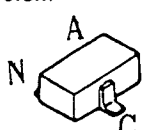
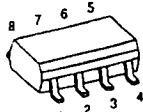
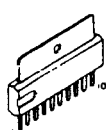
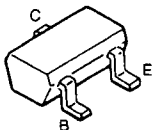
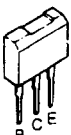

For Service Manuals Contact  
**MAURITRON TECHNICAL SERVICES**  
 8 Cherry Tree Rd, Chinnor  
 Oxon OX9 4QY  
 Tel: 01844-351694 Fax: 01844-352554  
 Email: enquiries@mauritron.co.uk

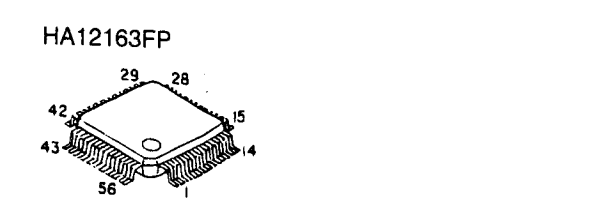
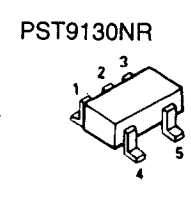
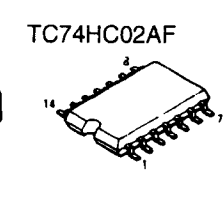
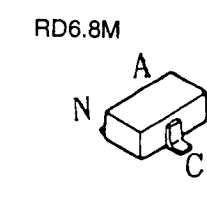
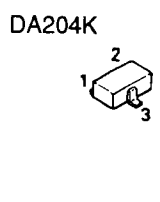
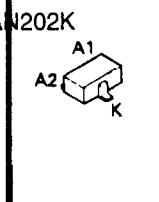
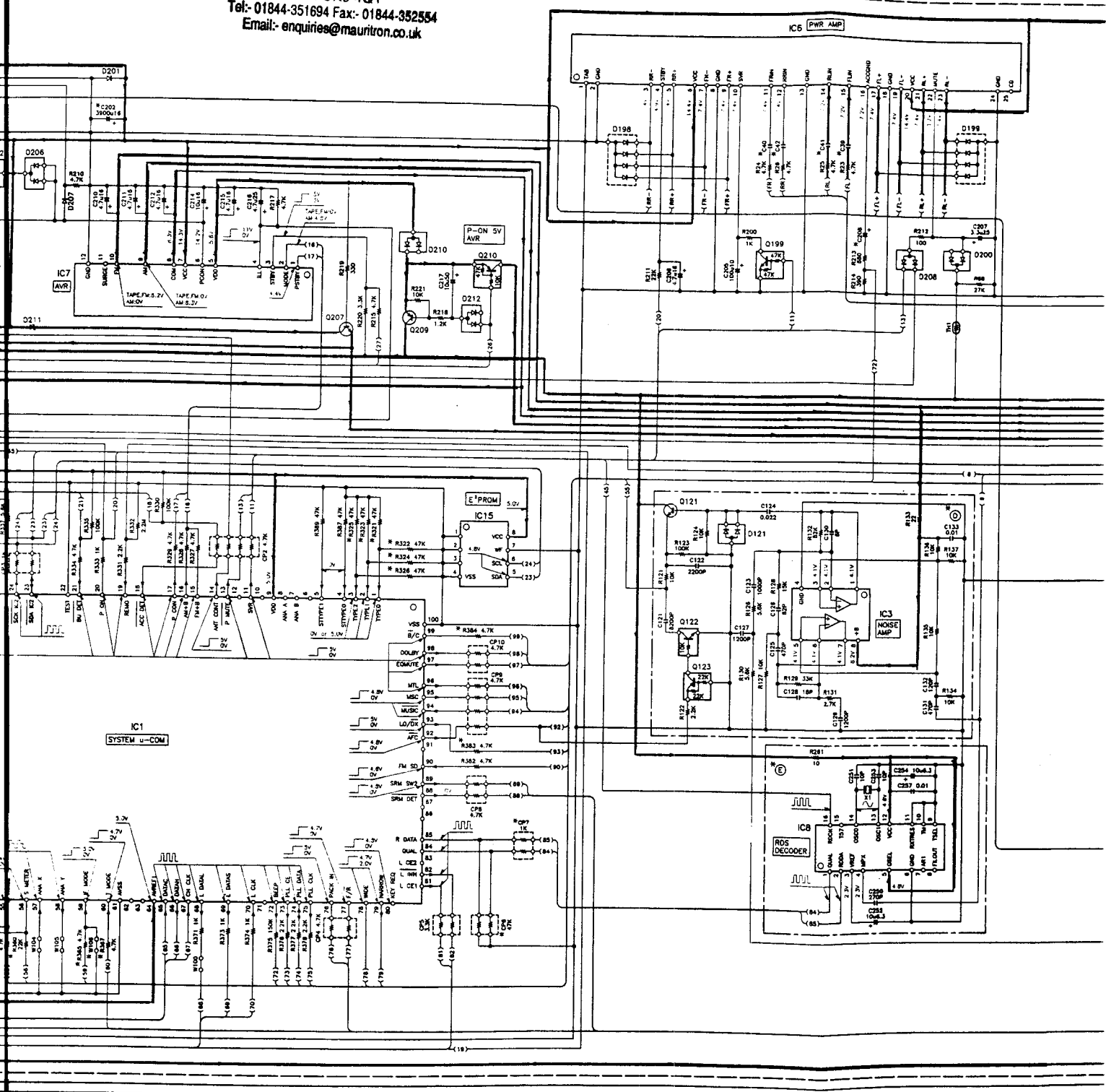

For Service Manuals Contact  
**MAURITRON TECHNICAL SERVICES**  
 8 Cherry Tree Rd, Chinnor  
 Oxon OX9 4QY  
 Tel: 01844-351894 Fax: 01844-352554  
 Email: enquiries@mauritron.co.uk

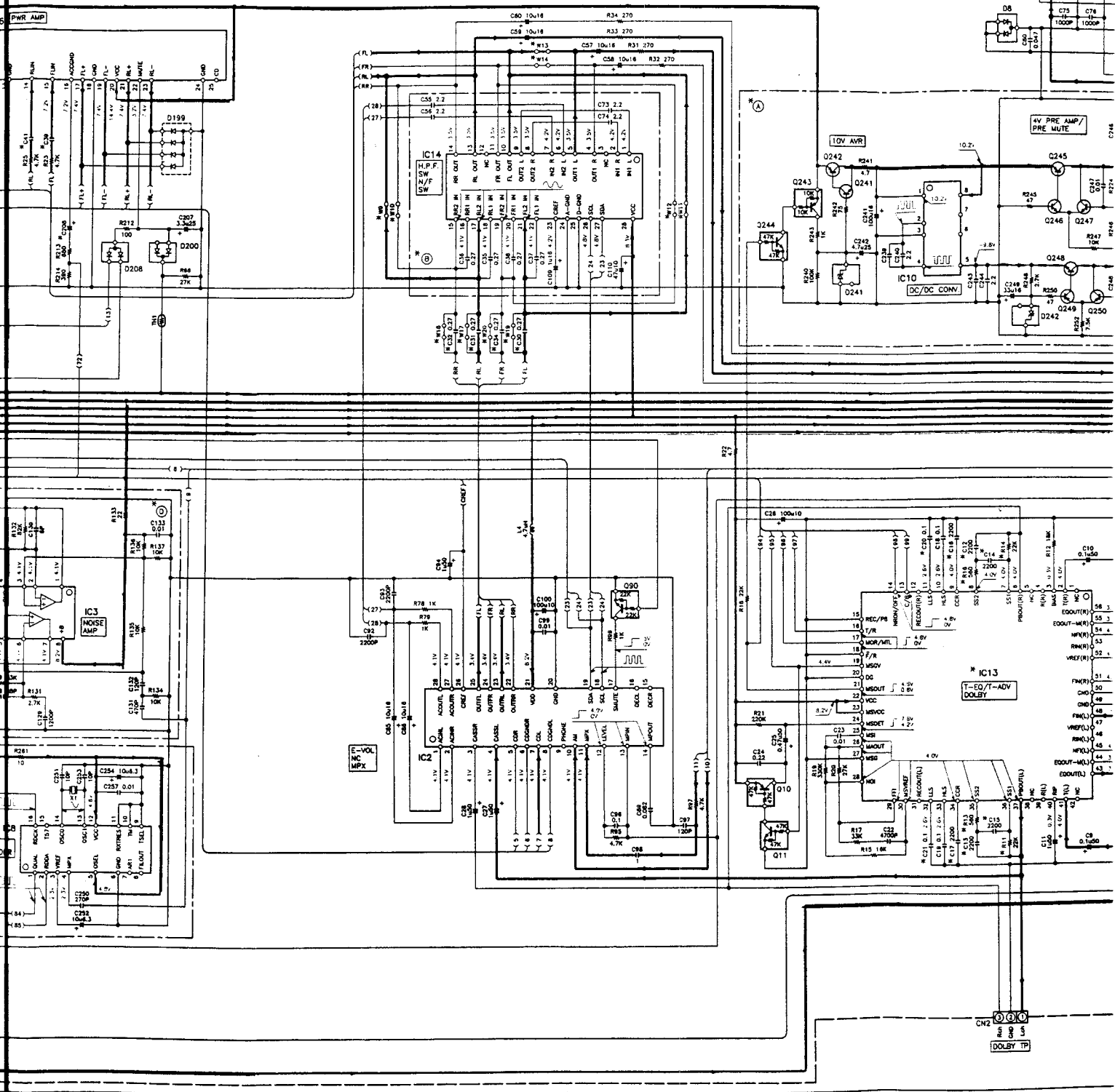

DC voltages are as measured with a high impedance voltmeter. Values may vary slightly due to variations between individual instruments or/and units.

**CAUTION:** For continued safety, replace components only with manufacturer's recommendation (refer to, parts list).  $\Delta$  Indicates safety critical. To reduce the risk of electric shock, leakage resistance measurements shall be carried out on acceptable insulated from the supply circuit appliance is returned to the customer.



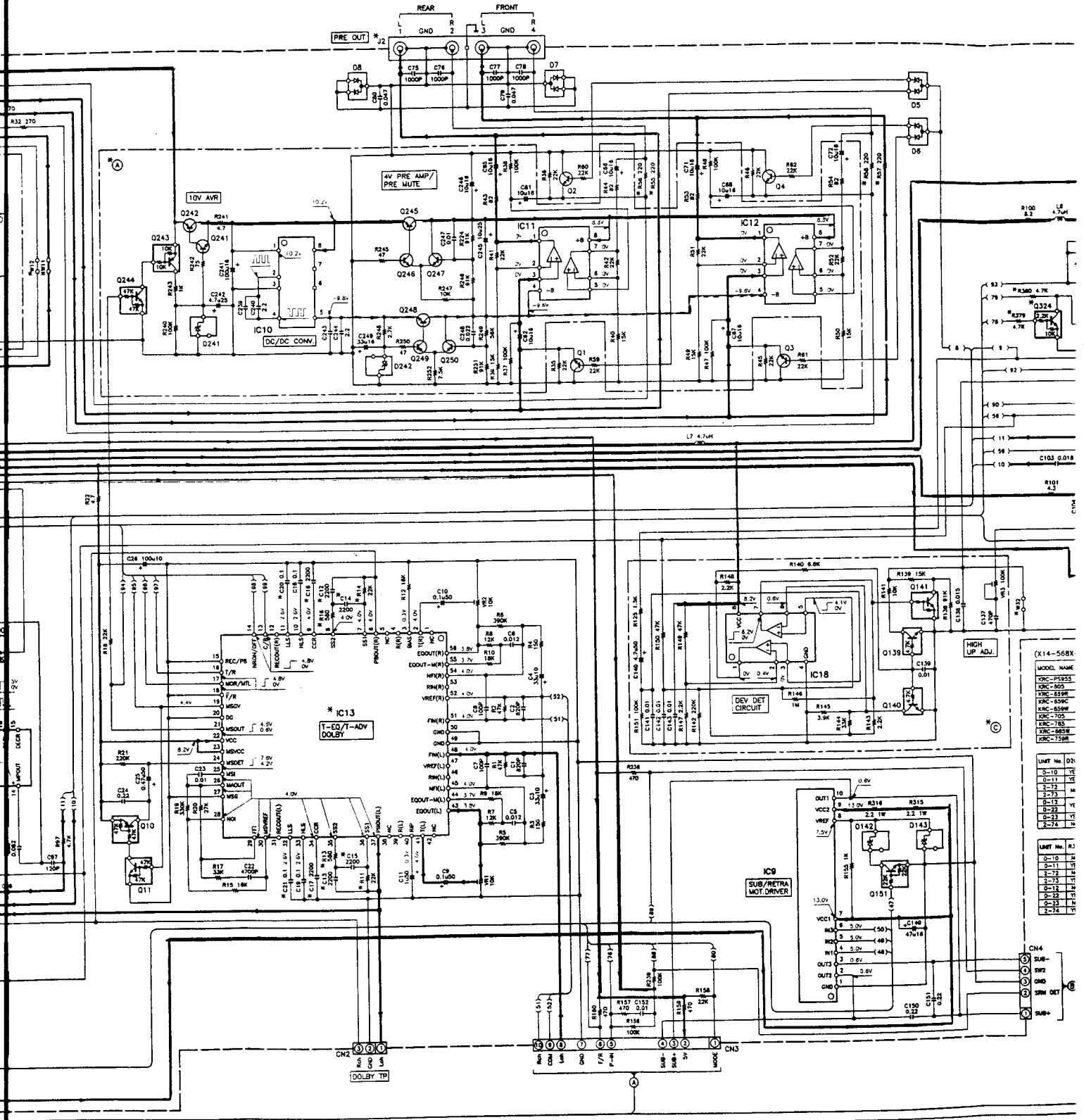

(X14-568X)

MODEL NAME	
KRC-PS935	
KRC-605	
KRC-839	
KRC-859C	
KRC-859E	
KRC-705	
KRC-659E	
KRC-759E	

UNIT No. D21	
0-10	YE
0-11	YE
2-12	W
2-13	W
0-12	YE
0-22	YE
0-23	YE
2-24	W

  

UNIT No. R1	
0-10	W
0-11	W
2-12	W
2-13	W
0-12	W
0-22	W
0-23	W
2-24	W

ance voltmeter.  
 sen individual

**CAUTION:** For continued safety, replace safety critical components only with manufacturer's recommended parts (refer to, parts list). **⚠** Indicates safety critical components. To reduce the risk of electric shock, leakage-current or resistance measurements shall be carried out (exposed parts are acceptably insulated from the supply circuit) before the appliance is returned to the customer.

**For Service Manuals Contact**  
**MAURITRON TECHNICAL SERVICES**  
 8 Charnock Road, Chinnor  
 Oxon OX9 4DY  
 Tel: 01844-351693 Fax: 01844-351694  
 Email: [service@mauritron.co.uk](mailto:service@mauritron.co.uk)

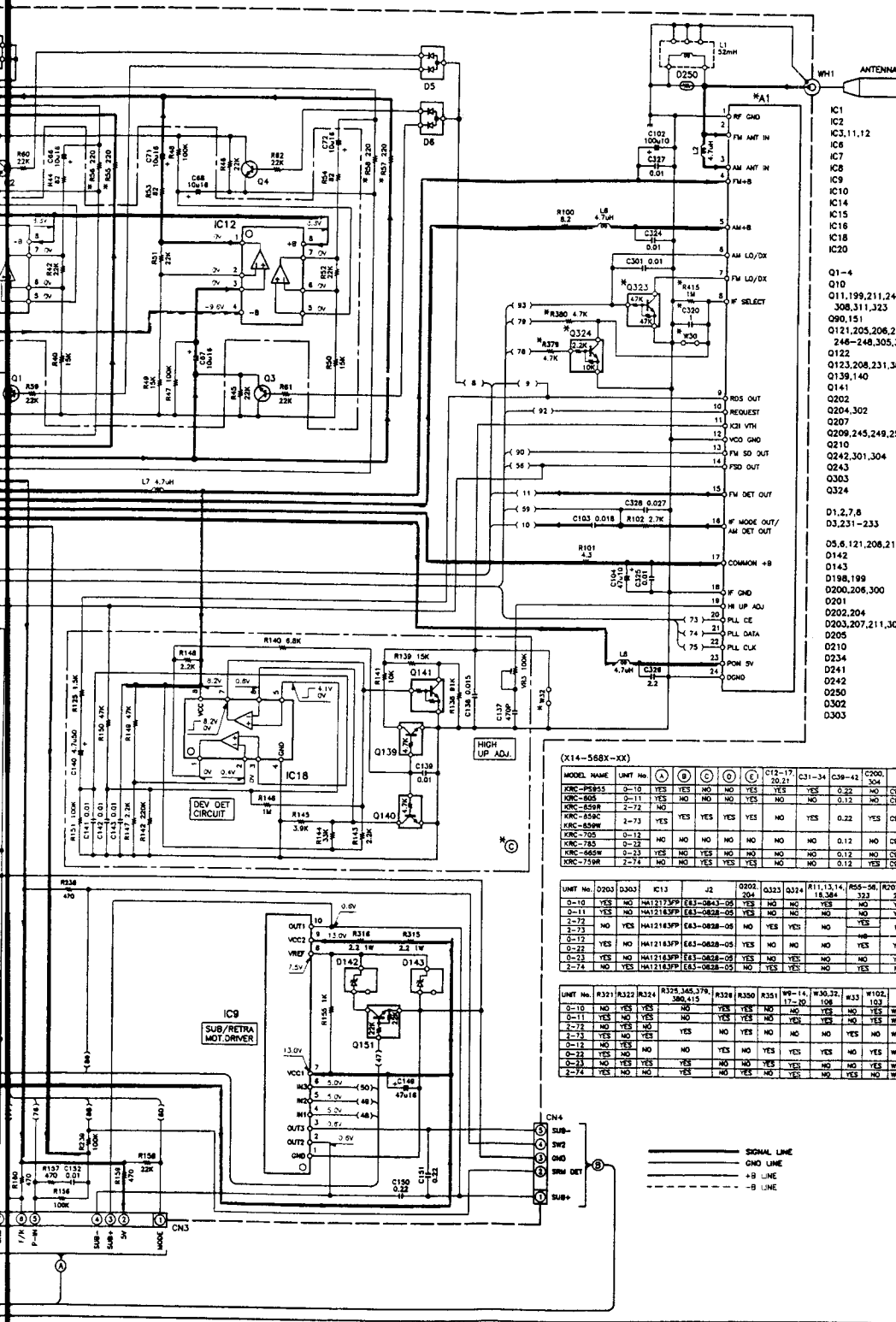

- IC1 : UP07842150F522
- IC2 : TDA7461D
- IC3,11,12 : NUM455M-TE2
- IC6 : TDA7386
- IC7 : BA3917-V4
- IC8 : TDA7479D
- IC9 : BA6238A
- IC10 : TC7660SECA
- IC14 : TDA7435
- IC15 : KX206F
- IC16 : TC74HC02AF
- IC18 : NUM2903M
- IC20 : PST9130NR
- Q1-4 : 2S02114K
- Q10 : O11,199,211,244,308,311,323,090,151 : DTC144EK
- Q121,205,206,241,246-248,305,307 : DTC124EK
- Q122 : 2SC2412K
- Q123,208,231,308 : DTC1147K
- Q139,140 : DTC1437K
- Q141 : DTC1247K
- Q202 : 2SB1277(Q,R)
- Q204,302 : DTC1147K
- Q207 : 2S0176D
- Q209,245,249,250 : 2SA1037K
- Q210 : DTA1147K
- Q242,301,304 : 2SB1443
- Q243 : DTA114EK
- Q303 : 2SB1184
- Q324 : DTD1237K
- O1,2,7,8 : DA204K
- O3,231-233 : MA3062WA
- O5,6,121,208,212,235 : DAP202K
- O142 : MA3068-M
- O143 : MA3075-M
- D198,199 : DCA80R
- D200,206,300 : DAN202K
- O201 : RM102LF
- O202,204 : RM8.5M(B2)
- O203,207,211,301 : AM01Z
- O205 : M1F60
- O210 : 1SS181
- D234 : MA3082-M
- D241 : H2M11N(B1)
- D242 : MA3056-M
- O250 : O5P-301W-A21F
- O302 : H2M22M(B3)
- O303 : MA3047-M

(X14-568X-XX)

MODEL NAME	UNIT No.	Q1	Q2	Q3	Q4	Q12-17	Q20,21	Q31-34	Q39-42	Q200	Q204	Q207	Q208	Q320	Q38	Q39	
KRC-PS815	0-10	YES	NO	NO	YES	YES	YES	YES	YES	NO	NO	NO	NO	NO	NO	NO	NO
KRC-805	0-11	YES	NO	NO	NO	YES	NO	NO	NO	NO	NO	NO	NO	NO	NO	NO	NO
KRC-859R	2-72	NO	NO	NO	NO	NO	NO	NO	NO	NO	NO	NO	NO	NO	NO	NO	NO
KRC-859C	2-73	YES	YES	YES	YES	YES	NO	YES	0.22	YES	C90-2854-05	1	YES	NO	YES	NO	YES
KRC-705	0-12	NO	NO	NO	NO	NO	NO	NO	0.12	NO	C90-2854-05	0.47	NO	YES	NO	NO	NO
KRC-785	0-22	NO	NO	NO	NO	NO	NO	NO	0.12	NO	C90-2854-05	0.47	YES	YES	NO	NO	NO
KRC-685W	0-23	YES	NO	YES	NO	NO	NO	NO	0.12	NO	C90-2854-05	0.47	YES	YES	NO	NO	NO
KRC-759R	2-74	NO	NO	YES	YES	YES	YES	NO	0.12	NO	C90-2854-05	0.47	YES	YES	NO	NO	NO

UNIT No.	D200	D300	IC11	J2	Q202	Q323	Q334	R11,13,14,16,304	R35-36	RC02,207	R256,317-319,306
0-10	YES	NO	HA12173PF	EA3-0843-05	YES	NO	NO	YES	NO	YES	NO
0-11	YES	NO	HA12163PF	EA3-0828-05	YES	NO	NO	NO	NO	NO	YES
2-72	NO	YES	HA12163PF	EA3-0828-05	NO	YES	YES	NO	NO	NO	NO
2-73	NO	YES	NO	NO	NO	NO	NO	NO	NO	NO	YES
0-12	YES	NO	HA12163PF	EA3-0828-05	YES	NO	NO	NO	NO	YES	YES
0-23	YES	NO	HA12163PF	EA3-0828-05	YES	NO	YES	NO	NO	NO	NO
2-74	NO	YES	HA12163PF	EA3-0828-05	NO	YES	YES	NO	NO	YES	NO

UNIT No.	R321	R322	R323,345,378,380,415	R328	R330	R331	W8-14,17-20	W30,37,40	#35	W102,103	A1
0-10	NO	YES	YES	YES	YES	NO	NO	YES	NO	YES	W02-3118-05
0-11	YES	NO	NO	YES	YES	NO	NO	YES	NO	YES	W02-3118-05
2-72	NO	NO	NO	NO	NO	NO	NO	NO	NO	NO	W02-3123-05
2-73	NO	NO	NO	NO	NO	NO	NO	NO	NO	NO	W02-3123-05
0-12	NO	NO	NO	NO	NO	NO	NO	NO	NO	NO	W02-3118-05
0-22	YES	NO	YES	NO	YES	YES	YES	YES	NO	YES	W02-3123-05
0-23	NO	YES	YES	NO	NO	NO	NO	NO	NO	YES	W02-3123-05
2-74	YES	NO	NO	YES	NO	NO	NO	NO	NO	YES	W02-3123-05

For Service Manuals Contact  
**MAURITRON TECHNICAL SERVICES**  
 8 Cherry Tree Rd, Chinnor  
 Oxon OX9 4QY  
 Tel: 01944-351694 Fax: 01844-352554  
 Email: enquires@mauritron.co.uk



1/2

**KRC-705/759R/RY/785/805/859C**  
**/CY/R/RY/W/WY/885W/PS955**

**KENWOOD**

(X13-9140-10)

For Service Manuals Contact  
**MAURITRON TECHNICAL SERVICES**  
 8 Cherry Tree Rd, Chimmer  
 Exon OX9 4QY  
 Tel: 01844-351694 Fax: 01844-352554  
 Email: enquiries@mauriton.co.uk

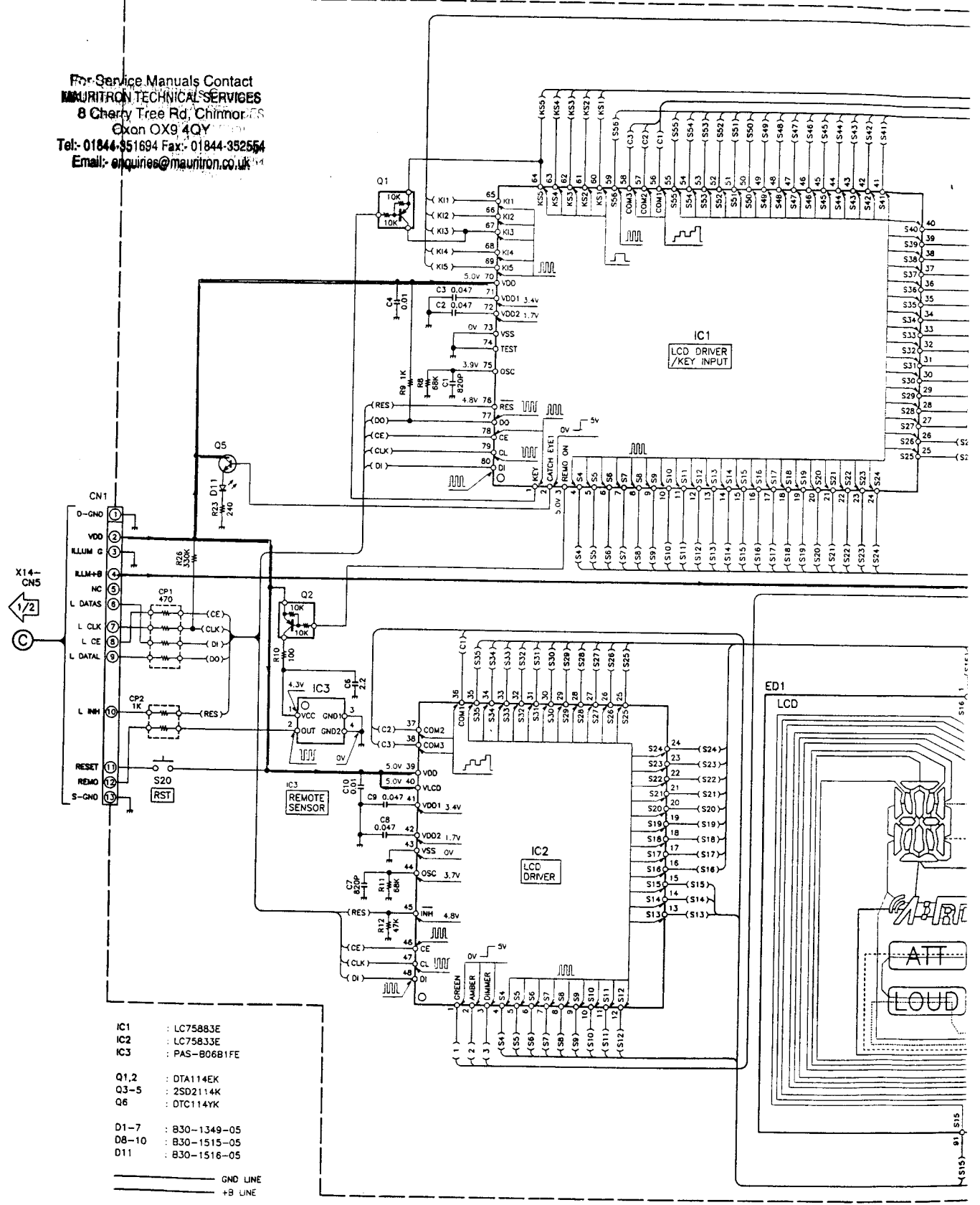

- IC1 : LC75883E
- IC2 : LC75833E
- IC3 : PAS-806B1FE
- Q1,2 : DTA114EK
- Q3-5 : 2SD2114K
- Q6 : DTC114YK
- D1-7 : B30-1349-05
- D8-10 : B30-1515-05
- D11 : B30-1516-05

— GND LINE  
 +B LINE

DC voltages are as measured with a high impedance voltmeter. Values may vary slightly due to variations between individual instruments or/and units

**CAUTION:** For continued safety, replace safety critical components only with manufacturer's recommended parts (refer to, parts list).  $\Delta$  Indicates safety critical components. To reduce the risk of electric shock, leakage-current or resistance measurements shall be carried out (exposed parts are acceptably insulated from the supply circuit) before the appliance is returned to the customer.

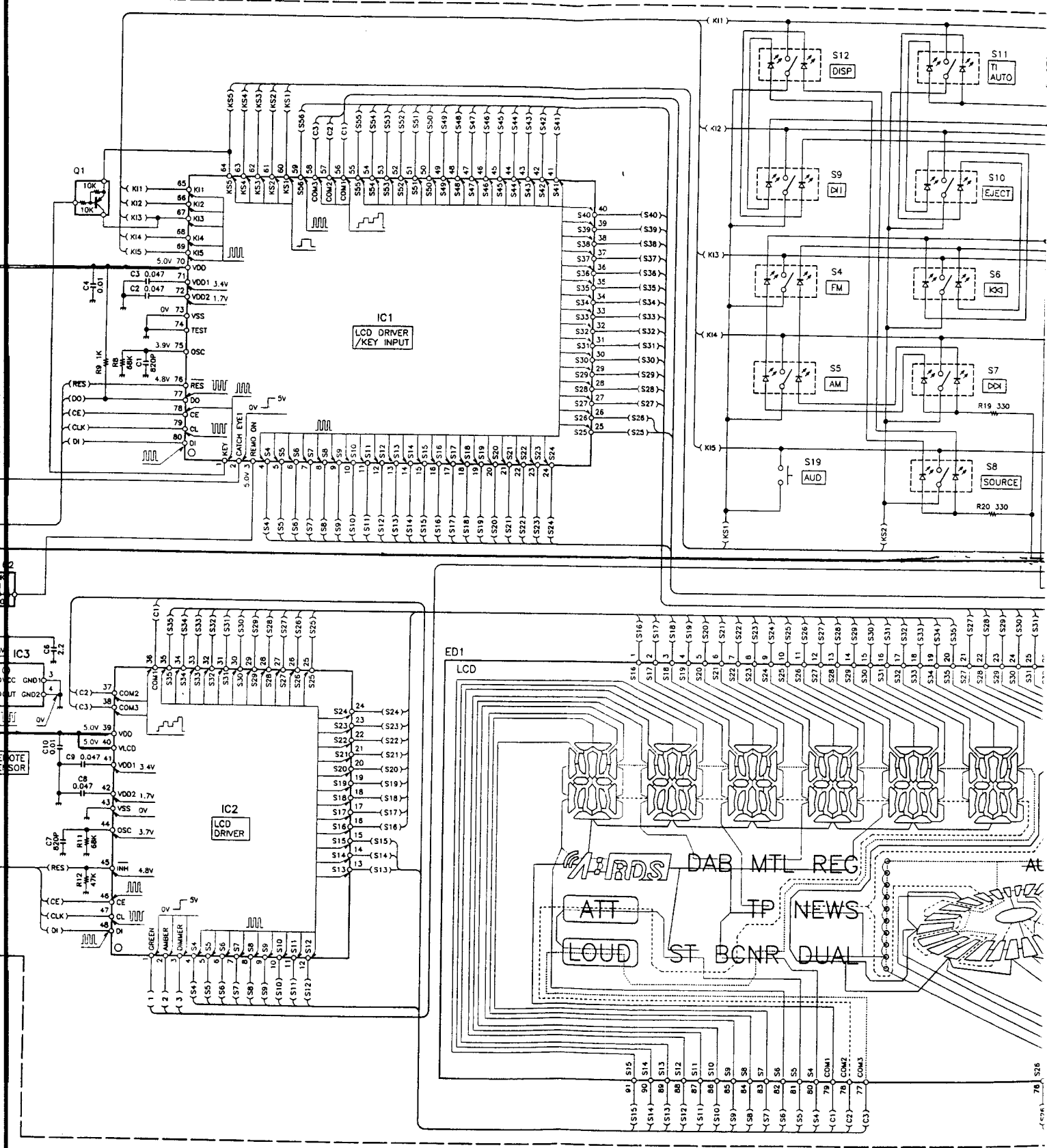

high impedance voltmeter.  
connections between individual

**CAUTION:** For continued safety, replace safety critical components only with manufacturer's recommended parts (refer to, parts list).  $\Delta$  Indicates safety critical components. To reduce the risk of electric shock, leakage-current or resistance measurements shall be carried out (exposed parts are acceptably insulated from the supply circuit) before the appliance is returned to the customer.

For Service Manuals Contact  
**MAURITRON TECHNICAL SERVICES**  
 8 Cherry Tree Rd Chinnor  
 Oxon OX9 4QY  
 Tel: 01844-351834 or 01844-352554  
 Email: enquiries@mauritron.co.uk

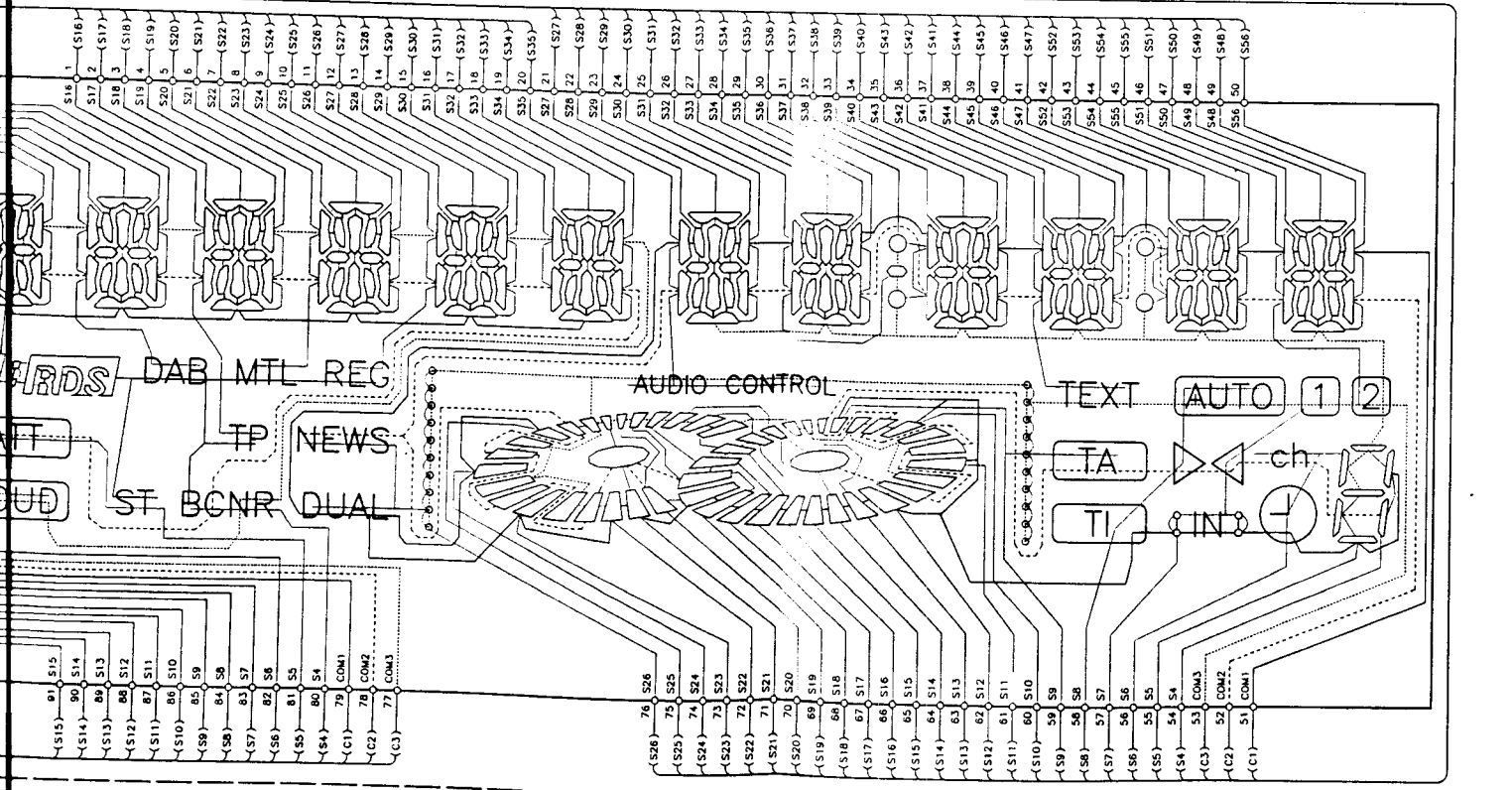
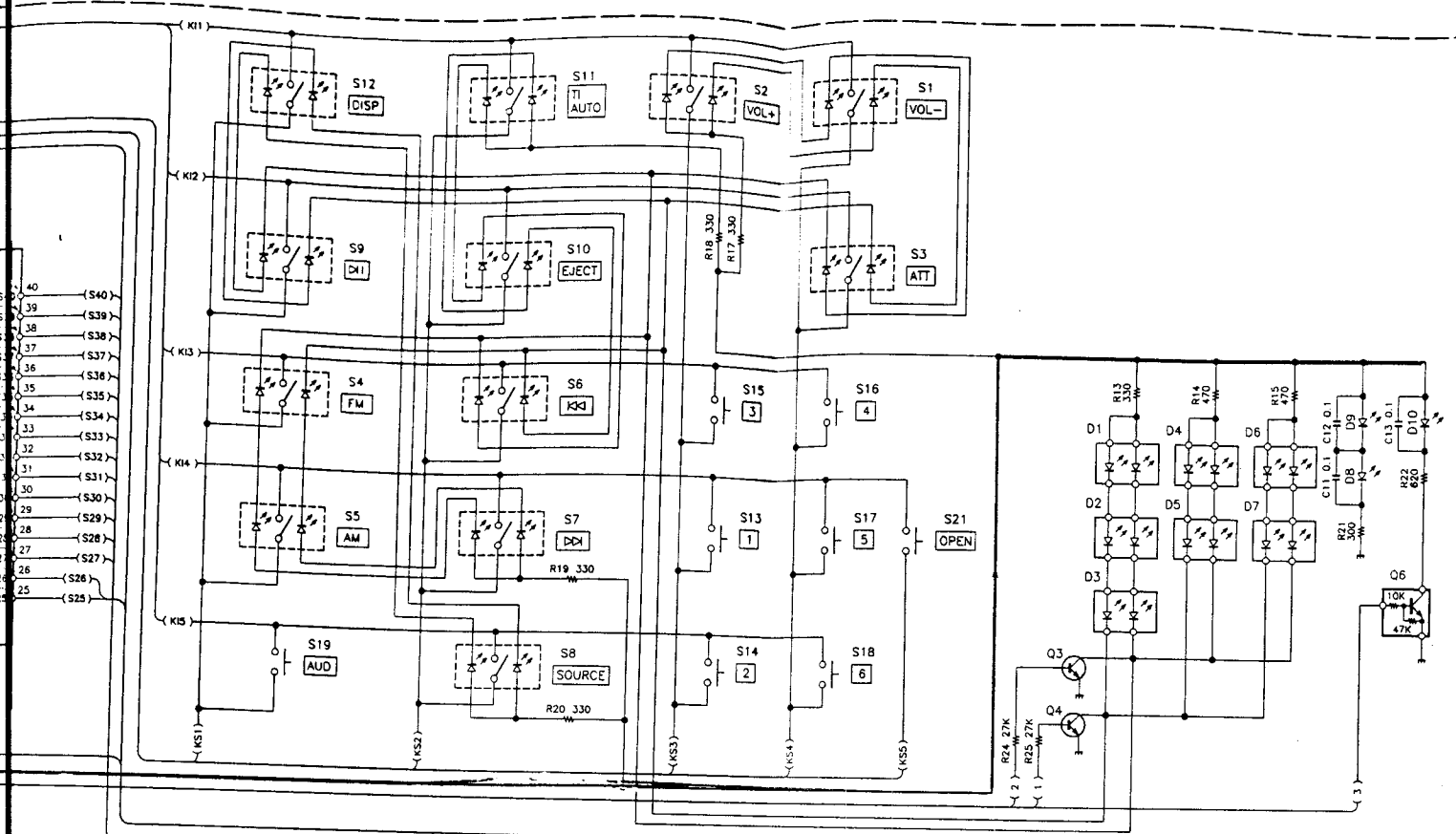

For Service Manuals Contact  
**MAURITRON TECHNICAL SERVICES**  
 8 Cherry Tree Rd, Chinnor  
 Oxon OX9 4QY  
 Tel: 01844-351694 Fax: 01844-352554  
 Email: enquiries@mauritron.co.uk

**KRC-705/759R/Ry/785/805/859C**  
**/CY/R/Ry/W/WY/885W/PS955**

KRC-705/759R/RY/785/805/859C  
/CY/R/RY/W/WY/885W/PS955

EXPLODED VIEW (MECHANISM)

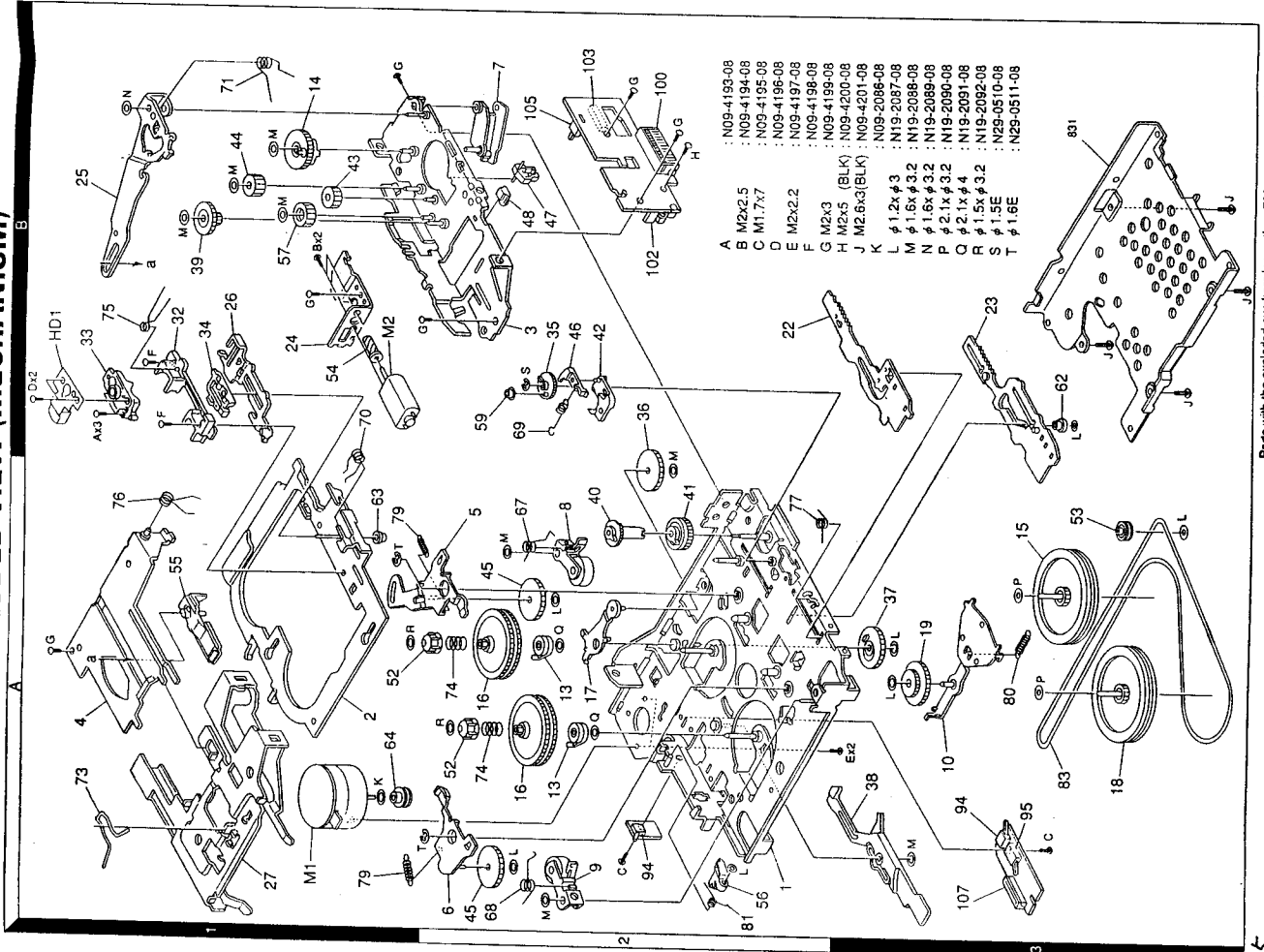

KRC-705/759R/RY/785/805/859C  
/CY/R/RY/W/WY/885W/PS955

EXPLODED VIEW (MAIN)

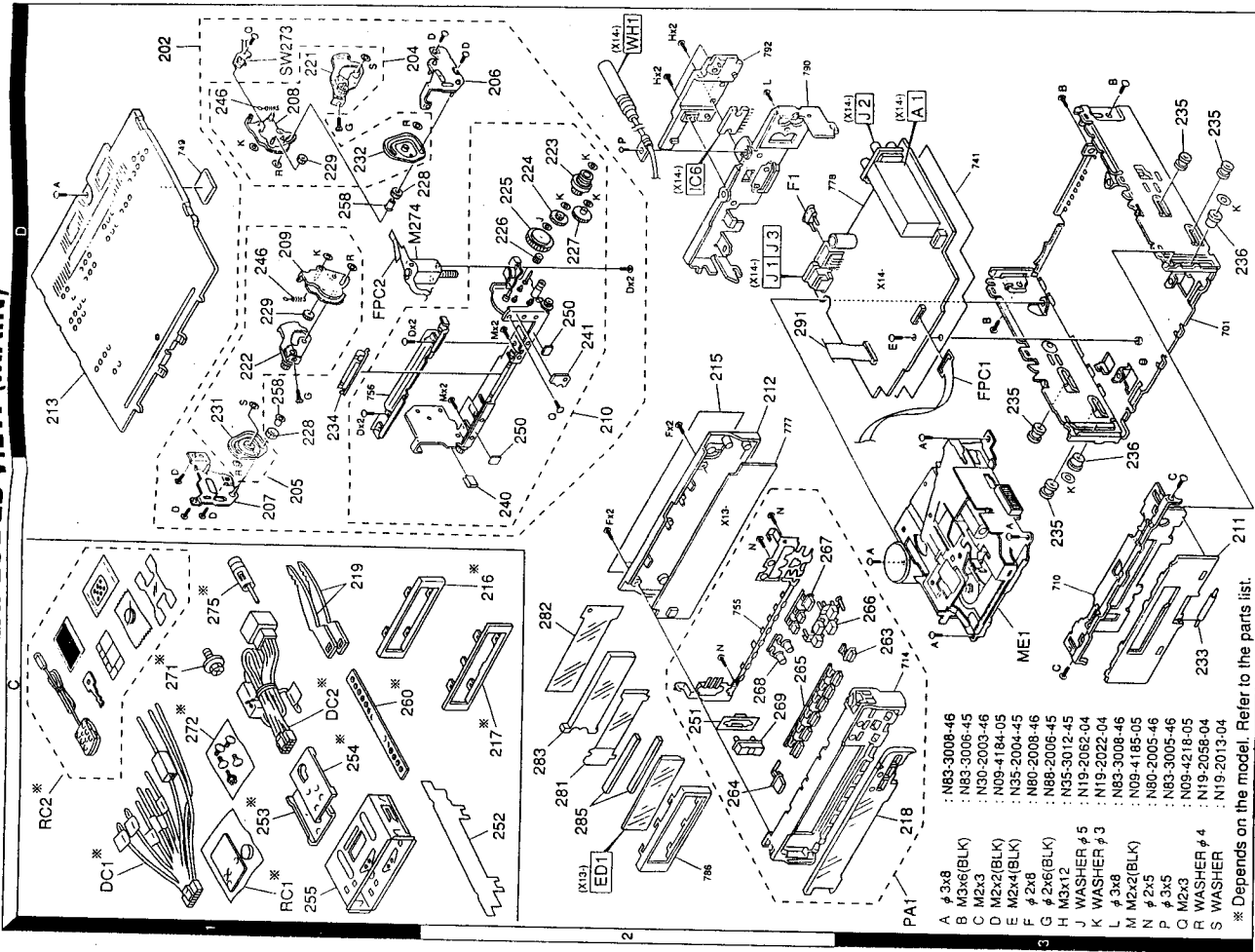

For Service Manuals Contact  
MAURITRON TECHNICAL SERVICES  
8 Cherry Tree Rd, Chinnor  
Oxon OX9 4QY  
Tel: 01844-351694 Fax: 01844-352854  
Email: enquiries@mauratron.co.uk

For Service Manuals Contact  
**MAURITRON TECHNICAL SERVICES**  
 8 Cherry Tree Rd. Chinnor  
 Oxon OX9 4QY  
 Tel: 01844-351694 Fax: 01844-352554  
 Email: enquiries@maurtron.co.uk

# KRC-705/759R/R/RY/785/805/859C /CY/R/R/RY/W/WY/885W/PS955

## PARTS LIST

\*New Parts

Parts without Parts No. are not supplied.

Les articles non mentionnes dans le Parts No. ne sont pas fournis.

Teile ohne Parts No. werden nicht geliefert.

Ref.No.	A d d w	N e w	Parts No.	Description	Dest inati on
<b>KRC-705 /759R/R/RY /785 /805 /859C/CY/R/R/RY/W/WY /885W /PS955</b>					
202	1D	*	A10-4428-22	CHASSIS ASSY	
204	1D	*	A10-4313-62	CHASSIS ASSY	
205	1D	*	A10-4314-62	CHASSIS ASSY	
206	2D	*	A10-4315-04	CHASSIS CALKING ASSY	
207	1D	*	A10-4317-04	CHASSIS CALKING ASSY	
208	1D	*	A10-4319-04	CHASSIS CALKING ASSY	
209	1D	*	A10-4321-04	CHASSIS CALKING ASSY	
210	2D		A10-4353-53	CHASSIS ASSY	
211	3C	*	A22-2271-03	SUB PANEL ASSY	
212	2C	*	A46-1273-02	REAR COVER	K0
212	2C	*	A46-1279-02	REAR COVER (GRAY)	E2E3E4
212	2C	*	A46-1279-02	REAR COVER (GRAY)	E5E8E9
212	2C	*	A46-1279-02	REAR COVER (GRAY)	K1K2M2
212	2C	*	A46-1280-02	REAR COVER (BROWN)	E6E7
212	2C	*	A46-1280-02	REAR COVER (BROWN)	M3
213	1D		A52-0708-12	TOP PLATE	
PA1	3C	*	A64-1187-02	PANEL ASSY	K0
PA1	3C	*	A64-1188-02	PANEL ASSY	K1
PA1	3C	*	A64-1189-02	PANEL ASSY	K2
PA1	3C	*	A64-1191-02	PANEL ASSY	M2
PA1	3C	*	A64-1192-02	PANEL ASSY	M3
PA1	3C	*	A64-1194-02	PANEL ASSY	E2E3
PA1	3C	*	A64-1195-02	PANEL ASSY	E4E5
PA1	3C	*	A64-1196-02	PANEL ASSY	E6E7
PA1	3C	*	A64-1197-02	PANEL ASSY	E8E9
RC1	1C	*	A70-0860-05	REMOTE CONTROLLER ASSY(CA-R6	K0K1M2
RC1	1C	*	A70-0860-05	REMOTE CONTROLLER ASSY(CA-R6	M3
RC2	1C	*	A70-0874-05	REMOTE CONTROLLER ASSY	E2E3E4
RC2	1C	*	A70-0874-05	REMOTE CONTROLLER ASSY	E5E6E7
215	2D	*	B03-3026-03	DRESSING SEAL	K0
215	2D	*	B03-3027-03	DRESSING SEAL (GRAY)	E2E3E8
215	2D	*	B03-3027-03	DRESSING SEAL (GRAY)	E9
215	2D	*	B03-3027-03	DRESSING SEAL (GRAY)	K1K2M2
215	2D	*	B03-3029-03	DRESSING SEAL (WOODY)	E6E7
215	2D	*	B03-3029-03	DRESSING SEAL (WOODY)	M3
215	2D	*	B03-3030-03	DRESSING SEAL (CARBONISH)	E4E5
216	1C	*	B07-2113-03	ESCUTCHEON ASSY	K0
216	1C	*	B07-2114-03	ESCUTCHEON ASSY	E4E5
216	1C	*	B07-2115-03	ESCUTCHEON ASSY	E6E7
216	1C	*	B07-2115-03	ESCUTCHEON ASSY	M3
216	1C	*	B07-2118-03	ESCUTCHEON ASSY	E2E3E8
216	1C	*	B07-2118-03	ESCUTCHEON ASSY	E9
216	1C	*	B07-2118-03	ESCUTCHEON ASSY	K1K2M2
217	1C	*	B07-2096-72	ESCUTCHEON (BLK)	K0
217	1C	*	B07-2116-02	ESCUTCHEON (CF(W))	M3
217	1C	*	B07-2117-02	ESCUTCHEON (GRAY)	K1K2M2
218	3C	*	B10-2813-01	FRONT GLASS	K0
218	3C	*	B10-2814-01	FRONT GLASS	K1
218	3C	*	B10-2815-01	FRONT GLASS	K2
218	3C	*	B10-2817-01	FRONT GLASS	M2
218	3C	*	B10-2818-01	FRONT GLASS	M3
218	3C	*	B10-2820-01	FRONT GLASS	E2E3
218	3C	*	B10-2821-01	FRONT GLASS	E4E5

Ref.No.	A d d w	N e w	Parts No.	Description	Dest inati on
218	3C	*	B10-2822-01	FRONT GLASS	E6E7
218	3C	*	B10-2823-01	FRONT GLASS	E8E9
-			B46-0100-50	WARRANTY CARD	K0K1K2
-			B46-0100-50	WARRANTY CARD	M2M3
-			B46-0100-50	WARRANTY CARD	E2E4E6
-			B46-0100-50	WARRANTY CARD	E8
-			B46-0172-13	QUESTIONNAIRE CARD	K0K1K2
-			B46-0612-14	ID CARD	E2E3E4
-			B46-0612-14	ID CARD	E5E6E7
-			B46-0612-14	ID CARD	E8E9
-			B46-0612-14	ID CARD	M2M3
-			B58-1255-04	CAUTION CARD (SRM)	K0K1K2
-			B58-1255-04	CAUTION CARD (SRM)	M2M3
-			B58-1255-04	CAUTION CARD (SRM)	E2E4E6
-			B58-1255-04	CAUTION CARD (SRM)	E8
-		*	B58-1278-04	CAUTION CARD	K0K1K2
-		*	B58-1278-04	CAUTION CARD	M2M3
-		*	B58-1278-04	CAUTION CARD	E2E4E6
-		*	B58-1278-04	CAUTION CARD	E8
-			B58-1282-04	CAUTION CARD (SRM)	E3E5E7
-			B58-1282-04	CAUTION CARD (SRM)	E9
-			B58-1283-04	CAUTION CARD	E3E5E7
-			B58-1283-04	CAUTION CARD	E9
-		*	B64-1157-00	INST. MANUAL (ENG., FRE., SPA.)	K0K1K2
-		*	B64-1158-00	INST. MANUAL (ENG., CHI.)	M2M3
-		*	B64-1159-00	INST. MANUAL (ENG., FRE.)	E2E4E6
-		*	B64-1159-00	INST. MANUAL (ENG., FRE.)	E8
-		*	B64-1160-00	INST. MANUAL (GER., ITA.)	E2E4E6
-		*	B64-1160-00	INST. MANUAL (GER., ITA.)	E8
-		*	B64-1161-00	INST. MANUAL (DUT., POR.)	E2E4E6
-		*	B64-1161-00	INST. MANUAL (DUT., POR.)	E8
-		*	B64-1162-00	INST. MANUAL (SPA.)	E2E4E6
-		*	B64-1162-00	INST. MANUAL (SPA.)	E8
-		*	B64-1163-00	INST. MANUAL (ENG., RUS.)	E3E5E7
-		*	B64-1163-00	INST. MANUAL (ENG., RUS.)	E9
-		*	B64-1164-00	INST. MANUAL (POL., CZE.)	E3E5E7
-		*	B64-1164-00	INST. MANUAL (POL., CZE.)	E9
219	1C		D10-4067-14	LEVER	
221	1D		D10-4139-13	ARM ASSY	
222	1D		D10-4140-13	ARM ASSY	
223	2D		D13-1302-64	GEAR ASSY	
224	1D		D13-1306-14	GEAR	
225	2D		D13-1348-03	GEAR	
226	2D		D13-1349-04	GEAR	
227	2D		D13-1350-04	GEAR	
228	1D		D13-1312-24	GEAR	
229	2D		D13-1313-04	GEAR	
231	1D		D13-1320-13	GEAR ASSY	
232	1D		D13-1321-13	GEAR ASSY	
233	3C		D14-0676-04	ROLLER	
234	1D		D14-0678-04	ROLLER ASSY	
235	3D		D14-0680-34	ROLLER	
236	3D		D14-0681-34	ROLLER	
ME1	3C	*	D40-1082-15	CASSETTE MECHANISM ASSY	

E: Europe K: North America M: Other Areas  
 W: Without Europe

E2: KRC-859R  
 E3: KRC-859RY  
 E4: KRC-859C

E5: KRC-859CY  
 E6: KRC-859W  
 E7: KRC-859WY

E8: KRC-759R  
 E9: KRC-759RY

K0: KRC-PS955  
 K1: KRC-805  
 K2: KRC-705

M2: KRC-785  
 M3: KRC-885W

▲ indicates safety critical components.

# KRC-705/759R/R/785/805/859C /CY/R/R/W/WY/885W/PS955

For Service Manuals Contact  
MAURITRON TECHNICAL SERVICES  
8 Cherry Tree Rd. CHIRRH  
Oxon OX9 4QV  
Tel: 01844-351694 Fax: 01844-352554  
Email: enquiries@mauritron.co.uk

## PARTS LIST

\*New Parts  
Parts without Parts No. are not supplied.  
Les articles non mentionnés dans le Parts No. ne sont pas fournis.  
Teile ohne Parts No. werden nicht geliefert.

Ref.No.	A d d w	N e w	Parts No.	Description	Dest inati on	Ref.No.	A d d w	N e w	Parts No.	Description	Dest inati on
△DC1	1C	*	E30-4549-05	DC CORD	KOK1K2	267	2C	*	K25-0853-03	KNOB (SRC)	
△DC1	1C	*	E30-4549-05	DC CORD	M2M3	268	2C	*	K25-0854-03	KNOB (DISP)	
△DC2	1C	*	E30-4551-05	DC CORD (ISO)	E2E3E4	269	2C	*	K25-0876-03	KNOB (VOL)	
△DC2	1C	*	E30-4551-05	DC CORD (ISO)	E5E6E7						
△DC2	1C	*	E30-4551-05	DC CORD (ISO)	E8E9						
240	2D		F09-1244-04	SHEET		271	1C		N09-1885-05	SEMS (MACHINE SCREW)	E2E3E4
241	2D	*	F09-1255-04	SHEET		271	1C		N09-1885-05	SEMS (MACHINE SCREW)	E5E6E7
△F1	2D		F52-0006-05	FUSE(MINI BLADE TYPE)		271	1C		N09-1885-05	SEMS (MACHINE SCREW)	E8E9
						272	1C		N99-1652-05	SCREW SET	KOK1K2
						272	1C		N99-1652-05	SCREW SET	M2M3
246	1D		G01-2818-24	EXTENSION SPRING		A	3C		N83-3008-46	PAN HEAD TAPTITE SCREW	
250	2D		G11-1733-04	CUSHION		B	3D		N83-3006-45	PAN HEAD TAPTITE SCREW	
251	2C	*	G11-1756-04	CUSHION		C	3C		N30-2003-46	PAN HEAD MACHINE SCREW	
252	2C	*	G16-1084-04	SHEET		D	1D		N09-4184-05	MACHINE SCREW (M2X2)	
						E	3D		N35-2004-46	BINDING HEAD MACHINE SCREW	
-			H10-4564-02	POLYSTYRENE FOAMED FIXTURE		F	2C		N80-2008-46	PAN HEAD TAPTITE SCREW	
-			H13-1681-04	CARTON BOARD		G	1D		N88-2006-45	FLAT HEAD TAPTITE SCREW	
-			H21-1118-04	PROTECTION SHEET		J	2D		N19-2062-04	FLAT WASHER	
-			H21-1120-04	PROTECTION SHEET		K	2D		N19-2022-04	FLAT WASHER	
-			H25-0329-04	PROTECTION BAG (280X450)	KOK1K2	M	1D		N09-4185-05	MACHINE SCREW (M2X2)	
-			H25-0329-04	PROTECTION BAG (280X450)	M2M3	N	2C		N80-2005-46	PAN HEAD TAPTITE SCREW	
-			H25-0329-04	PROTECTION BAG (280X450)	E3E5E7	Q	1D		N09-4218-05	MACHINE SCREW (M2X3)	
-			H25-0329-04	PROTECTION BAG (280X450)	E9	R	1D		N19-2058-04	FLAT WASHER	
-			H25-0337-04	PROTECTION BAG (180X300)	E2E3E4	S	1D		N19-2103-04	FLAT WASHER	
-			H25-1108-04	PROTECTION BAG (100X300)	E5E6E7	SW273	1D		S68-0829-05	PUSH SWITCH	
-			H25-1108-04	PROTECTION BAG (100X300)	E8E9						
-			H25-1108-04	PROTECTION BAG (100X300)	M2M3	275	1C		T90-0512-05	ANTENNA ADAPTOR	E2E3E4
-			H25-1111-04	PROTECTION BAG (280X450)	E2E4E6	275	1C		T90-0512-05	ANTENNA ADAPTOR	E5E6E7
-			H25-1111-04	PROTECTION BAG (280X450)	E8	275	1C		T90-0512-05	ANTENNA ADAPTOR	E8E9
-			* H54-1054-14	ITEM CARTON CASE	K0	M274	1D		T42-0752-14	MOTOR ASSY	
-			* H54-1056-14	ITEM CARTON CASE	K1	<b>SWITCH UNIT(X13-9140-10)</b>					
-			* H54-1057-14	ITEM CARTON CASE	K2	281	2C	*	B11-0941-04	OPTICAL DIFFUSER	
-			* H54-1058-14	ITEM CARTON CASE	M2	282	2C	*	B11-0942-04	REFLECTION SHEET	
-			* H54-1059-14	ITEM CARTON CASE	M3	283	2C	*	B19-1118-03	LIGHTING BOARD	
-			* H54-1061-14	ITEM CARTON CASE	E2	D1 -7			B30-1349-05	LED	
-			* H54-1062-14	ITEM CARTON CASE	E4	D8 -10		*	B30-1515-05	LED	
-			* H54-1063-14	ITEM CARTON CASE	E6	D11		*	B30-1516-05	LED	
-			* H54-1064-14	ITEM CARTON CASE	E8	ED1		*	B38-0687-05	LIQUID CRYSTAL	
-			* H54-1090-14	ITEM CARTON CASE	E3	C1			CK73FB1H821K	CHIP C	820PF K
-			* H54-1091-14	ITEM CARTON CASE	E5	C2 ,3			CK73FB1E473KTA	CHIP C	0.047UF K
-			* H54-1092-14	ITEM CARTON CASE	E7	C4			CK73FB1H103K	CHIP C	0.010UF K
-			* H54-1093-14	ITEM CARTON CASE	E9	C6			CK73EB1C225K	CHIP C	2.2UF K
253	1C		J19-4720-04	BRACKET (L)	KOK1K2	C7			CK73FB1H821K	CHIP C	820PF K
253	1C		J19-4720-04	BRACKET (L)	M2M3	C8 ,9			CK73FB1E473KTA	CHIP C	0.047UF K
254	1C		J19-4721-04	BRACKET (R)	KOK1K2	C10			CK73FB1H103K	CHIP C	0.010UF K
254	1C		J19-4721-04	BRACKET (R)	M2M3	C11 -13			CK73FB1C104K	CHIP C	0.10UF K
255	1C		J21-7934-03	MOUNTING HARDWARE ASSY		285	2C	*	E29-1541-04	CONDUCTIVE RUBBER	
258	1D		J31-1035-14	COLLAR		CN1			E40-9407-05	FLAT CABLE CONNECTOR	
260	1C		J54-0606-04	STAY	KOK1K2	CP1			R90-1016-05	MULTIPLE RESISTOR	
260	1C		J54-0606-04	STAY	M2M3	CP2			R90-0725-05	MULTI-COMP 1K X2	
FPC1	3D		J84-0061-33	FLEXIBLE P. WIRING BOARD		R8			RK73FB2A683J	CHIP R	68K J 1/10W
FPC2	1D		J84-0062-23	FLEXIBLE P. WIRING BOARD		R9			RK73FB2A102J	CHIP R	1.0K J 1/10W
263	2C	*	K24-1825-04	KNOB (AUD)		R10			RK73FB2A101J	CHIP R	100 J 1/10W
264	2C	*	K25-0874-03	KNOB (ATT)		R11			RK73FB2A683J	CHIP R	68K J 1/10W
265	2C	*	K25-0851-03	KNOB (PRESET 1-6)		R12			RK73FB2A473J	CHIP R	47K J 1/10W
266	2C	*	K25-0852-03	KNOB (FM/AM)							

E: Europe K: North America M: Other Areas  
W: Without Europe  
△ indicates safety critical components.

E2: KRC-859R E5: KRC-859CY E8: KRC-759R K0: KRC-PS955 M2: KRC-785  
E3: KRC-859RY E6: KRC-859W E9: KRC-759RY K1: KRC-805 M3: KRC-885W  
E4: KRC-859C E7: KRC-859WY K2: KRC-705



# KRC-705/759R/RV/785/805/859C /CY/R/RV/W/WY/885W/PS955

## PARTS LIST

New Parts  
 Parts without Parts No. are not supplied.  
 Les articles non mentionnes dans le Parts No. ne sont pas fournis.  
 Teile ohne Parts No. werden nicht geliefert.

Ref.No.	A d d w	N e w	Parts No.	Description	Dest inati on
13			RK73EB2B331J	CHIP R 330 J 1/8W	
14, 15			RK73EB2B471J	CHIP R 470 J 1/8W	
17 -20			RK73EB2B331J	CHIP R 330 J 1/8W	
21			RK73EB2B301J	CHIP R 300 J 1/8W	
22			RK73EB2B621J	CHIP R 620 J 1/8W	
23			RK73EB2B241J	CHIP R 240 J 1/8W	
24, 25			RK73FB2A273J	CHIP R 27K J 1/10W	
26			RK73FB2A334J	CHIP R 330K J 1/10W	
31 -12			S70-0839-05	TACT SWITCH	
313 -20			S70-0813-05	TACT SWITCH	
321			S70-0821-05	TACT SWITCH	
3C1			LC75883E	MOS-IC	
3C2			LC75833E	MOS-IC	
3C3			PAS-806B1FE	ANALOGUE IC	
3C1, 2			DTA114EK	DIGITAL TRANSISTOR	
3C1, 2			UN2111	DIGITAL TRANSISTOR	
3C3 -5			2SD2114K	TRANSISTOR	
3C5			DTC114YK	DIGITAL TRANSISTOR	
3C5			UN2214	DIGITAL TRANSISTOR	

### SYNTHESIZER UNIT(X14-568X-XX)

3C1, 2			CK73FB1H821K	CHIP C 820PF K	
3C3, 4			C90-2857-05	ELECTRO 33UF 10WV	
3C5, 6			CK73FB1H123K	CHIP C 0.012UF K	
3C7, 8			CC73FCH1H101J	CHIP C 100PF J	
3C9, 10			C90-2602-05	ELECTRO 0.10UF 50WV	
3C11			C90-2608-05	ELECTRO 1.0UF 50WV	
3C12 -17			CK73FB1H222K	CHIP C 2200PF K	KO
3C18 -21			CK73FB1C104K	CHIP C 0.10UF K	KO
3C18, 19			CK73FB1C104K	CHIP C 0.10UF K	E2E3E4
3C18, 19			CK73FB1C104K	CHIP C 0.10UF K	E5E6E7
3C18, 19			CK73FB1C104K	CHIP C 0.10UF K	E8E9
3C18, 19			CK73FB1C104K	CHIP C 0.10UF K	K1K2M2
3C18, 19			CK73FB1C104K	CHIP C 0.10UF K	M3
3C22			CK73FB1H472K	CHIP C 4700PF K	
3C23			CK73FB1H103K	CHIP C 0.010UF K	
3C24			CK73FB1C224K	CHIP C 0.22UF K	
3C25			C90-2606-05	ELECTRO 0.47UF 50WV	
3C26			CE04CW1A101M	ELECTRO 100UF 10WV	
3C27, 28			C90-2608-05	ELECTRO 1.0UF 50WV	
3C31 -38			CK73FB1C274K	CHIP C 0.27UF K	E2E3E4
3C31 -38			CK73FB1C274K	CHIP C 0.27UF K	E5E6E7
3C31 -38			CK73FB1C274K	CHIP C 0.27UF K	KO
3C39 -42			CK73FB1C124K	CHIP C 0.12UF K	E8E9
3C39 -42			CK73FB1C124K	CHIP C 0.12UF K	K1K2M2
3C39 -42			CK73FB1C124K	CHIP C 0.12UF K	M3
3C39 -42			CK73FB1C224K	CHIP C 0.22UF K	E2E3E4
3C39 -42			CK73FB1C224K	CHIP C 0.22UF K	E5E6E7
3C39 -42			CK73FB1C224K	CHIP C 0.22UF K	KO
3C47 -54			CK73FB1H153KTA	CHIP C 0.015UF K	E2E3E4
3C47 -54			CK73FB1H153KTA	CHIP C 0.015UF K	E5E6E7
3C47 -54			CK73FB1H153KTA	CHIP C 0.015UF K	E8E9
3C55, 56			CK73EB1C225K	CHIP C 2.2UF K	E2E3E4
3C55, 56			CK73EB1C225K	CHIP C 2.2UF K	E5E6E7
3C55, 56			CK73EB1C225K	CHIP C 2.2UF K	KO

Ref.No.	A d d w	N e w	Parts No.	Description	Dest inati on
C57 -60			C92-0671-05	ELECTRO 10UF 16WV	
C61, 62			C90-2597-05	ELECTRO 10UF 16WV	E4E5E6
C61, 62			C90-2597-05	ELECTRO 10UF 16WV	E7
C61, 62			C90-2597-05	ELECTRO 10UF 16WV	KOK1M3
C65 -68			C90-2597-05	ELECTRO 10UF 16WV	E4E5E6
C65 -68			C90-2597-05	ELECTRO 10UF 16WV	E7
C65 -68			C90-2597-05	ELECTRO 10UF 16WV	KOK1M3
C71, 72			C90-2597-05	ELECTRO 10UF 16WV	E4E5E6
C71, 72			C90-2597-05	ELECTRO 10UF 16WV	E7
C71, 72			C90-2597-05	ELECTRO 10UF 16WV	KOK1M3
C73, 74			CK73EB1C225K	CHIP C 2.2UF K	E2E3E4
C73, 74			CK73EB1C225K	CHIP C 2.2UF K	E5E6E7
C73, 74			CK73EB1C225K	CHIP C 2.2UF K	KO
C75 -78			CK73FB1H102K	CHIP C 1000PF K	
C79, 80			CK73FB1E473KTA	CHIP C 0.047UF K	
C85, 86			C92-0671-05	ELECTRO 10UF 16WV	
C89			CK73FB1C823K	CHIP C 0.082UF K	
C92, 93			CK73FB1H222K	CHIP C 2200PF K	
C94			C92-0686-05	ELECTRO 1UF 50WV	
C96			CK73FB1C104K	CHIP C 0.10UF K	
C97			CC73FCH1H121J	CHIP C 120PF J	
C98			CK73EB1C105K	CHIP C 1.0UF K	
C99			CK73FB1H103K	CHIP C 0.010UF K	
C100			CE04CW1A101M	ELECTRO 100UF 10WV	
C102			CE04DW1A101M	ELECTRO 100UF 10WV	
C103			CK73FB1H183KTA	CHIP C 0.018UF K	
C104			C90-2990-05	ELECTRO 47UF 10WV	
C109			C92-0686-05	ELECTRO 1UF 50WV	E2E3E4
C109			C92-0686-05	ELECTRO 1UF 50WV	E5E6E7
C109			C92-0686-05	ELECTRO 1UF 50WV	KO
C110			CE04CW1A470M	ELECTRO 47UF 10WV	E2E3E4
C110			CE04CW1A470M	ELECTRO 47UF 10WV	E5E6E7
C110			CE04CW1A470M	ELECTRO 47UF 10WV	KO
C121			CK73FB1H822K	CHIP C 8200PF K	E2E3E4
C121			CK73FB1H822K	CHIP C 8200PF K	E5E6E7
C121			CK73FB1H822K	CHIP C 8200PF K	E8E9
C122			CK73FB1H222K	CHIP C 2200PF K	E2E3E4
C122			CK73FB1H222K	CHIP C 2200PF K	E5E6E7
C122			CK73FB1H222K	CHIP C 2200PF K	E8E9
C123			CK73FB1H102K	CHIP C 1000PF K	E2E3E4
C123			CK73FB1H102K	CHIP C 1000PF K	E5E6E7
C123			CK73FB1H102K	CHIP C 1000PF K	E8E9
C124			CK73FB1H223KTA	CHIP C 0.022UF K	E2E3E4
C124			CK73FB1H223KTA	CHIP C 0.022UF K	E5E6E7
C124			CK73FB1H223KTA	CHIP C 0.022UF K	E8E9
C125			CK73FB1H471K	CHIP C 470PF K	E2E3E4
C125			CK73FB1H471K	CHIP C 470PF K	E5E6E7
C125			CK73FB1H471K	CHIP C 470PF K	E8E9
C126			CC73FCH1H820J	CHIP C 82PF J	E2E3E4
C126			CC73FCH1H820J	CHIP C 82PF J	E5E6E7
C126			CC73FCH1H820J	CHIP C 82PF J	E8E9
C127			CK73FB1H122K	CHIP C 1200PF K	E2E3E4
C127			CK73FB1H122K	CHIP C 1200PF K	E5E6E7
C127			CK73FB1H122K	CHIP C 1200PF K	E8E9
C128			CC73FCH1H180J	CHIP C 18PF J	E2E3E4

E: Europe K: North America M: Other Areas  
 W: Without Europe  
 \* indicates safety critical components.

E2: KRC-859R E5: KRC-859CY E8: KRC-759R K0: KRC-PS955 M2: KRC-785  
 E3: KRC-859RY E6: KRC-859W E9: KRC-759RY K1: KRC-805 M3: KRC-885W  
 E4: KRC-859C E7: KRC-859WY K2: KRC-705

For Service Manuals Contact  
**MAURITRON TECHNICAL SERVICES**  
 8 Cherry Tree Rd, Chinnor  
 Oxon OX9 4QY  
 Tel: 01844-351694 Fax: 01844-352554  
 Email: enquiries@mauratron.co.uk

# KRC-705/759R/R/RY/785/805/859C /CY/R/R/W/WY/885W/PS955

For Service Manuals Contact  
MAURITRON TECHNICAL SERVICES  
8 Cherry Tree Rd, Chinnor  
Oxon OX9 4QY  
Tel: 01844-351694 Fax: 01844-352554  
Email: enquiries@mauritron.co.uk

\*New Parts

Parts without Parts No. are not supplied.

Les articles non mentionnes dans le Parts No. ne sont pas fournis.

Teile ohne Parts No. werden nicht geliefert.

## PARTS LIST

SYNTHESIZER UNIT(X14-568X-XX)

Ref.No.	A d d	N e w	Parts No.	Description	Dest inati on	Ref.No.	A d d	N e w	Parts No.	Description	Dest inati on
C128			CC73FCH1H180J	CHIP C 18PF J	E5E6E7	C208			C90-2608-05	ELECTRO 1.0UF 50WV	E2E3E4
C128			CC73FCH1H180J	CHIP C 18PF J	E8E9	C208			C90-2608-05	ELECTRO 1.0UF 50WV	E5E6E7
C129			CK73FB1H122K	CHIP C 1200PF K	E2E3E4	C208			C90-2608-05	ELECTRO 1.0UF 50WV	KO
C129			CK73FB1H122K	CHIP C 1200PF K	E5E6E7	C210-212			C90-2595-05	ELECTRO 4.7UF 16WV	
C129			CK73FB1H122K	CHIP C 1200PF K	E8E9	C214			C90-2597-05	ELECTRO 10UF 16WV	
C130			CC73FCH1H060D	CHIP C 6.0PF D	E2E3E4	C215			C90-2595-05	ELECTRO 4.7UF 16WV	
C130			CC73FCH1H060D	CHIP C 6.0PF D	E5E6E7	C216			C90-2599-05	ELECTRO 4.7UF 25WV	
C130			CC73FCH1H060D	CHIP C 6.0PF D	E8E9	C217	*		C92-0667-05	ELECTRO 10UF 10WV	
C131			CK73FB1H471K	CHIP C 470PF K	E2E3E4	C230			CK73FB1H103K	CHIP C 0.010UF K	
C131			CK73FB1H471K	CHIP C 470PF K	E5E6E7	C235, 236			C90-2608-05	ELECTRO 1.0UF 50WV	
C131			CK73FB1H471K	CHIP C 470PF K	E8E9	C237, 238			CE04CWOJ470M	ELECTRO 47UF 6.3WV	
C132			CC73FCH1H121J	CHIP C 120PF J	E2E3E4	C239, 240			CK73EB1C225K	CHIP C 2.2UF K	E4E5E6
C132			CC73FCH1H121J	CHIP C 120PF J	E5E6E7	C239, 240			CK73EB1C225K	CHIP C 2.2UF K	E7
C132			CC73FCH1H121J	CHIP C 120PF J	E8E9	C239, 240			CK73EB1C225K	CHIP C 2.2UF K	KOK1M3
C133			CK73FB1H103K	CHIP C 0.010UF K	E2E3E4	C241	*		C90-2962-05	ELECTRO 100UF 16WV	E4E5E6
C133			CK73FB1H103K	CHIP C 0.010UF K	E5E6E7	C241	*		C90-2962-05	ELECTRO 100UF 16WV	E7
C133			CK73FB1H103K	CHIP C 0.010UF K	E8E9	C241	*		C90-2962-05	ELECTRO 100UF 16WV	KOK1M3
C137			CK73FB1H471K	CHIP C 470PF K	E2E3E4	C242			C92-0675-05	ELECTRO 4.7UF 25WV	E4E5E6
C137			CK73FB1H471K	CHIP C 470PF K	E5E6E7	C242			C92-0675-05	ELECTRO 4.7UF 25WV	E7
C137			CK73FB1H471K	CHIP C 470PF K	E8E9	C242			C92-0675-05	ELECTRO 4.7UF 25WV	KOK1M3
C137			CK73FB1H471K	CHIP C 470PF K	M3	C243, 244			CK73EB1C225K	CHIP C 2.2UF K	E4E5E6
C138			CK73FB1H153KTA	CHIP C 0.015UF K	E2E3E4	C243, 244			CK73EB1C225K	CHIP C 2.2UF K	E7
C138			CK73FB1H153KTA	CHIP C 0.015UF K	E5E6E7	C243, 244			CK73EB1C225K	CHIP C 2.2UF K	KOK1M3
C138			CK73FB1H153KTA	CHIP C 0.015UF K	E8E9	C245			CE04CW1E100M	ELECTRO 10UF 25WV	E4E5E6
C138			CK73FB1H153KTA	CHIP C 0.015UF K	M3	C245			CE04CW1E100M	ELECTRO 10UF 25WV	E7
C139			CK73FB1H103K	CHIP C 0.010UF K	E2E3E4	C245			CE04CW1E100M	ELECTRO 10UF 25WV	KOK1M3
C139			CK73FB1H103K	CHIP C 0.010UF K	E5E6E7	C246			C90-2597-05	ELECTRO 10UF 16WV	E4E5E6
C139			CK73FB1H103K	CHIP C 0.010UF K	E8E9	C246			C90-2597-05	ELECTRO 10UF 16WV	E7
C139			CK73FB1H103K	CHIP C 0.010UF K	M3	C246			C90-2597-05	ELECTRO 10UF 16WV	KOK1M3
C140			C92-0675-05	ELECTRO 4.7UF 25WV	E2E3E4	C247			CK73FB1H103K	CHIP C 0.010UF K	E4E5E6
C140			C92-0675-05	ELECTRO 4.7UF 25WV	E5E6E7	C247			CK73FB1H103K	CHIP C 0.010UF K	E7
C140			C92-0675-05	ELECTRO 4.7UF 25WV	E8E9	C247			CK73FB1H103K	CHIP C 0.010UF K	KOK1M3
C141-143			CK73FB1H103K	CHIP C 0.010UF K	M3	C248			CK73FB1H223KTA	CHIP C 0.022UF K	E4E5E6
C141-143			CK73FB1H103K	CHIP C 0.010UF K	E2E3E4	C248			CK73FB1H223KTA	CHIP C 0.022UF K	E7
C141-143			CK73FB1H103K	CHIP C 0.010UF K	E5E6E7	C248			CK73FB1H223KTA	CHIP C 0.022UF K	KOK1M3
C141-143			CK73FB1H103K	CHIP C 0.010UF K	E8E9	C249			CE04CW1C330M	ELECTRO 33UF 16WV	E4E5E6
C141-143			CK73FB1H103K	CHIP C 0.010UF K	M3	C249			CE04CW1C330M	ELECTRO 33UF 16WV	E7
C149			CE04CW1C470M	ELECTRO 47UF 16WV		C249			CE04CW1C330M	ELECTRO 33UF 16WV	KOK1M3
C150, 151			CK73FB1C224K	CHIP C 0.22UF K		C250			CC73FCH1H331J	CHIP C 330PF J	E2E3E4
C152			CK73FB1H103K	CHIP C 0.010UF K		C250			CC73FCH1H331J	CHIP C 330PF J	E5E6E7
C200			CK73FB1H103K	CHIP C 0.010UF K	E2E3E4	C250			CC73FCH1H331J	CHIP C 330PF J	E8E9
C200			CK73FB1H103K	CHIP C 0.010UF K	E5E6E7	C250			CC73FCH1H331J	CHIP C 330PF J	KOK1
C201	*		C92-0686-05	ELECTRO 1UF 50WV		C251			CC73FCH1H100D	CHIP C 10PF D	E2E3E4
C202			C90-2822-05	ELECTRO 3900UF 16WV	KO	C251			CC73FCH1H100D	CHIP C 10PF D	E5E6E7
C202			C90-2856-05	ELECTRO 3900UF 16WV	E2E3E4	C251			CC73FCH1H100D	CHIP C 10PF D	E8E9
C202			C90-2856-05	ELECTRO 3900UF 16WV	E5E6E7	C251			CC73FCH1H100D	CHIP C 10PF D	KOK1
C202			C90-2856-05	ELECTRO 3900UF 16WV	K1K2M2	C252			C90-2592-05	ELECTRO 10UF 6.3WV	E2E3E4
C202			C90-2856-05	ELECTRO 3900UF 16WV	M3	C252			C90-2592-05	ELECTRO 10UF 6.3WV	E5E6E7
C203, 204			CK73FB1H103K	CHIP C 0.010UF K		C252			C90-2592-05	ELECTRO 10UF 6.3WV	E8E9
C205			CE04CW1A101M	ELECTRO 100UF 10WV		C252			C90-2592-05	ELECTRO 10UF 6.3WV	KOK1
C206			C90-2595-05	ELECTRO 4.7UF 16WV		C253			CC73FCH1H100D	CHIP C 10PF D	E2E3E4
C207			C90-2598-05	ELECTRO 3.3UF 25WV		C253			CC73FCH1H100D	CHIP C 10PF D	E5E6E7
C208			C90-2606-05	ELECTRO 0.47UF 50WV	E8E9	C253			CC73FCH1H100D	CHIP C 10PF D	E8E9
C208			C90-2606-05	ELECTRO 0.47UF 50WV	K1K2M2	C253			CC73FCH1H100D	CHIP C 10PF D	KOK1
C208			C90-2606-05	ELECTRO 0.47UF 50WV	M3	C253			CC73FCH1H100D	CHIP C 10PF D	E2E3E4

E: Europe K: North America M: Other Areas  
W: Without Europe

▲ indicates safety critical components.

E2: KRC-859R E5: KRC-859CY E8: KRC-759R K0: KRC-PS955 M2: KRC-785  
E3: KRC-859RY E6: KRC-859W E9: KRC-759RY K1: KRC-805 M3: KRC-885W  
E4: KRC-859C E7: KRC-859WY K2: KRC-705

For Service Manuals Contact  
**MAURITRON TECHNICAL SERVICES**  
 8 Cherry Tree Rd, Chinnor  
 Oxon OX9 4QY  
 Tel: 01844-351694 Fax: 01844-352554  
 Email: enquiries@mauritron.co.uk

# KRC-705/759R/R/RY/785/805/859C /CY/R/R/RY/W/WY/885W/PS955

## PARTS LIST

SYNTHESIZER UNIT(X14-568X-XX)

\*New Parts

Parts without Parts No. are not supplied.

Les articles non mentionnes dans le Parts No. ne sont pas fournis.

Teile ohne Parts No. werden nicht geliefert.

Ref.No.	A d e w	Parts No.	Description	Dest ination
C254		C90-2592-05	ELECTRO 10UF 6.3WV	E5E6E7
C254		C90-2592-05	ELECTRO 10UF 6.3WV	E8E9
C254		C90-2592-05	ELECTRO 10UF 6.3WV	KOK1
C257		CK73FB1H103K	CHIP C 0.010UF K	E2E3E4
C257		CK73FB1H103K	CHIP C 0.010UF K	E5E6E7
C257		CK73FB1H103K	CHIP C 0.010UF K	E8E9
C257		CK73FB1H103K	CHIP C 0.010UF K	KOK1
C301, 302		CK73FB1H103K	CHIP C 0.010UF K	
C303		CK73EB1C105K	CHIP C 1.0UF K	
C304		CK73FB1H103K	CHIP C 0.010UF K	E2E3E4
C304		CK73FB1H103K	CHIP C 0.010UF K	E5E6E7
C304		CK73FB1H103K	CHIP C 0.010UF K	E8E9
C305		CK73FB1H472K	CHIP C 4700PF K	
C307		CE04CWOJ331M	ELECTRO 330UF 6.3WV	
C308		CK73FB1H103K	CHIP C 0.010UF K	
C309, 310		CC73FCH1H220J	CHIP C 22PF J	
C320		CK73EB1C105K	CHIP C 1.0UF K	E2E3E4
C320		CK73EB1C105K	CHIP C 1.0UF K	E5E6E7
C320		CK73EB1C105K	CHIP C 1.0UF K	E8E9
C320		CK73EB1C105K	CHIP C 1.0UF K	M3
C324, 325		CK73FB1H103K	CHIP C 0.010UF K	
C326		CK73EB1C225K	CHIP C 2.2UF K	
C327		CK73FB1H103K	CHIP C 0.010UF K	
C328		CK73FB1E273KTA	CHIP C 0.027UF K	
291	2D	E31-8094-05	LEAD WIRE	
CN2		E40-9184-05	PIN ASSY	
CN3		E40-9541-05	PIN ASSY	
CN4		E40-5029-05	FLAT CABLE CONNECTOR	
CN5		E40-9557-05	FLAT CABLE CONNECTOR	
J1		E56-0826-05	CYLINDRICAL RECEPTACLE	
J2		E63-0828-05	PHONO JACK	E2E3E4
J2		E63-0828-05	PHONO JACK	E5E6E7
J2		E63-0828-05	PHONO JACK	E8E9
J2		E63-0828-05	PHONO JACK	K1K2M2
J2		E63-0828-05	PHONO JACK	M3
J2		E63-0843-05	PHONO JACK	KO
J3		E58-0836-05	RECTANGULAR RECEPTACLE	
WH1	*	E30-4583-05	CORD WITH PLUG	
L1		L33-1039-05	LINE FILTER COIL	
L2		L40-4795-34	SMALL FIXED INDUCTOR	
L4	-8	L40-4795-34	SMALL FIXED INDUCTOR	
L12		L40-4795-34	SMALL FIXED INDUCTOR	
X1		L77-2002-05	CRYSTAL RESONATOR	E2E3E4
X1		L77-2002-05	CRYSTAL RESONATOR	E5E6E7
X1		L77-2002-05	CRYSTAL RESONATOR	E8E9
X1		L77-2002-05	CRYSTAL RESONATOR	KOK1
X2	*	L78-0574-05	RESONATOR	
X3		L78-0533-05	RESONATOR (32.768KHZ)	
H	2D	N35-3012-46	BINDING HEAD MACHINE SCREW	
L	2D	N80-3008-46	PAN HEAD TAPTITE SCREW	
P	2D	N83-3005-46	PAN HEAD TAPTITE SCREW	
CP2		R90-0718-05	MULTI-COMP 4.7K X4	
CP3		R90-0725-05	MULTI-COMP 1K X2	
CP4		R90-0719-05	MULTI-COMP 4.7K X2	

Ref.No.	A d e w	Parts No.	Description	Dest ination
CP5		* R90-1021-05	MULTI-COMP 3.3K X2	
CP6		R90-0723-05	MULTI-COMP 47K X2	K2M2
CP6		R90-0723-05	MULTI-COMP 47K X2	M3
CP7		R90-0725-05	MULTI-COMP 1K X2	E2E3E4
CP7		R90-0725-05	MULTI-COMP 1K X2	E5E6E7
CP7		R90-0725-05	MULTI-COMP 1K X2	E8E9
CP7		R90-0725-05	MULTI-COMP 1K X2	KOK1
CP8		R90-0719-05	MULTI-COMP 4.7K X2	
CP9		R90-0718-05	MULTI-COMP 4.7K X4	
CP10		R90-0719-05	MULTI-COMP 4.7K X2	
R1	, 2	RK73FB2A473J	CHIP R 47K J 1/10W	
R3	, 4	RK73FB2A151J	CHIP R 150 J 1/10W	
R5	, 6	RK73FB2A394J	CHIP R 390K J 1/10W	
R7	, 8	RK73FB2A123J	CHIP R 12K J 1/10W	
R9	, 10	RK73FB2A183J	CHIP R 18K J 1/10W	
R11		RK73FB2A223J	CHIP R 22K J 1/10W	KO
R12		RK73FB2A183J	CHIP R 18K J 1/10W	
R13		RK73FB2A561J	CHIP R 560 J 1/10W	KO
R14		RK73FB2A223J	CHIP R 22K J 1/10W	KO
R15		RK73FB2A163J	CHIP R 16K J 1/10W	
R16		RK73FB2A561J	CHIP R 560 J 1/10W	KO
R17		RK73FB2A333J	CHIP R 33K J 1/10W	
R18		RK73FB2A223J	CHIP R 22K J 1/10W	
R19		RK73FB2A334J	CHIP R 330K J 1/10W	
R20		RK73FB2A273J	CHIP R 27K J 1/10W	
R21		RK73FB2A224J	CHIP R 220K J 1/10W	
R22		RK73FB2A4R7J	CHIP R 4.7 J 1/10W	
R23	-26	RK73FB2A472J	CHIP R 4.7K J 1/10W	
R31	-34	RK73FB2A271J	CHIP R 270 J 1/10W	
R35	, 36	RK73FB2A223J	CHIP R 22K J 1/10W	
R37	, 38	RK73FB2A104J	CHIP R 100K J 1/10W	E4E5E6
R37	, 38	RK73FB2A104J	CHIP R 100K J 1/10W	E7
R37	, 38	RK73FB2A104J	CHIP R 100K J 1/10W	KOK1M3
R39	, 40	RK73FB2A153J	CHIP R 15K J 1/10W	E4E5E6
R39	, 40	RK73FB2A153J	CHIP R 15K J 1/10W	E7
R39	, 40	RK73FB2A153J	CHIP R 15K J 1/10W	KOK1M3
R41	, 42	RK73FB2A223J	CHIP R 22K J 1/10W	E4E5E6
R41	, 42	RK73FB2A223J	CHIP R 22K J 1/10W	E7
R41	, 42	RK73FB2A223J	CHIP R 22K J 1/10W	KOK1M3
R43	, 44	RK73FB2A820J	CHIP R 82 J 1/10W	E4E5E6
R43	, 44	RK73FB2A820J	CHIP R 82 J 1/10W	E7
R43	, 44	RK73FB2A820J	CHIP R 82 J 1/10W	KOK1M3
R45	, 46	RK73FB2A223J	CHIP R 22K J 1/10W	
R47	, 48	RK73FB2A104J	CHIP R 100K J 1/10W	E4E5E6
R47	, 48	RK73FB2A104J	CHIP R 100K J 1/10W	E7
R47	, 48	RK73FB2A104J	CHIP R 100K J 1/10W	KOK1M3
R49	, 50	RK73FB2A153J	CHIP R 15K J 1/10W	E4E5E6
R49	, 50	RK73FB2A153J	CHIP R 15K J 1/10W	E7
R49	, 50	RK73FB2A153J	CHIP R 15K J 1/10W	KOK1M3
R51	, 52	RK73FB2A223J	CHIP R 22K J 1/10W	E4E5E6
R51	, 52	RK73FB2A223J	CHIP R 22K J 1/10W	E7
R51	, 52	RK73FB2A223J	CHIP R 22K J 1/10W	KOK1M3
R53	, 54	RK73FB2A820J	CHIP R 82 J 1/10W	E4E5E6
R53	, 54	RK73FB2A820J	CHIP R 82 J 1/10W	E7
R53	, 54	RK73FB2A820J	CHIP R 82 J 1/10W	KOK1M3

E: Europe K: North America M: Other Areas  
 W: Without Europe  
 Δ indicates safety critical components.

E2: KRC-859R E5: KRC-859CY E8: KRC-759R K0: KRC-PS955 M2: KRC-785  
 E3: KRC-859RY E6: KRC-859W E9: KRC-759RY K1: KRC-805 M3: KRC-885W  
 E4: KRC-859C E7: KRC-859WY K2: KRC-705

# KRC-705/759R/RV/785/805/859C /CY/R/RV/W/WY/885W/PS955

For Service Manuals Contact  
Mauritron Electronics Services  
6 Sharnley Road, Chinnor  
Oxon OX9 4QY  
Tel: 01844 816118 Fax: 01844 855554  
Email: enquiries@maurtron.co.uk

\*New Parts  
Parts without Parts No. are not supplied.  
Les articles non mentionnes dans le Parts No. ne sont pas fournis.  
Teile ohne Parts No. werden nicht geliefert.

## PARTS LIST

### SYNTHESIZER UNIT(X14-568X-XX)

Ref.No.	A d d	N e w	Parts No.	Description	Dest inati on	Ref.No.	A d d	N e w	Parts No.	Description	Dest inati on
R55 -58			RK73FB2A221J	CHIP R 220 J 1/10W	E2E3E8	R138			RK73FB2A913J	CHIP R 91K J 1/10W	E2E3E4
R55 -58			RK73FB2A221J	CHIP R 220 J 1/10W	E9	R138			RK73FB2A913J	CHIP R 91K J 1/10W	E5E6E7
R55 -58			RK73FB2A221J	CHIP R 220 J 1/10W	K2M2	R138			RK73FB2A913J	CHIP R 91K J 1/10W	E8E9
R59 -62			RK73FB2A223J	CHIP R 22K J 1/10W		R138			RK73FB2A913J	CHIP R 91K J 1/10W	M3
R66			RK73FB2A273J	CHIP R 27K J 1/10W		R139			RK73FB2A153J	CHIP R 15K J 1/10W	E2E3E4
R78 ,79			RK73FB2A102J	CHIP R 1.0K J 1/10W		R139			RK73FB2A153J	CHIP R 15K J 1/10W	E5E6E7
R95			RK73FB2A472J	CHIP R 4.7K J 1/10W		R139			RK73FB2A153J	CHIP R 15K J 1/10W	E8E9
R97			RK73FB2A472J	CHIP R 4.7K J 1/10W		R139			RK73FB2A153J	CHIP R 15K J 1/10W	M3
R99			RK73FB2A102J	CHIP R 1.0K J 1/10W		R140			RK73FB2A682J	CHIP R 6.8K J 1/10W	E2E3E4
R100			RK73FB2A8R2J	CHIP R 8.2 J 1/10W		R140			RK73FB2A682J	CHIP R 6.8K J 1/10W	E5E6E7
R101		*	RK73FB2A4R3J	CHIP R 4.3 J 1/10W		R140			RK73FB2A682J	CHIP R 6.8K J 1/10W	E8E9
R102			RK73FB2A272J	CHIP R 2.7K J 1/10W		R140			RK73FB2A682J	CHIP R 6.8K J 1/10W	M3
R121			RK73FB2A103J	CHIP R 10K J 1/10W	E2E3E4	R141			RK73FB2A103J	CHIP R 10K J 1/10W	E2E3E4
R121			RK73FB2A103J	CHIP R 10K J 1/10W	E5E6E7	R141			RK73FB2A103J	CHIP R 10K J 1/10W	E5E6E7
R121			RK73FB2A103J	CHIP R 10K J 1/10W	E8E9	R141			RK73FB2A103J	CHIP R 10K J 1/10W	E8E9
R122			RK73FB2A222J	CHIP R 2.2K J 1/10W	E2E3E4	R141			RK73FB2A103J	CHIP R 10K J 1/10W	M3
R122			RK73FB2A222J	CHIP R 2.2K J 1/10W	E5E6E7	R142			RK73FB2A224J	CHIP R 220K J 1/10W	E2E3E4
R122			RK73FB2A222J	CHIP R 2.2K J 1/10W	E8E9	R142			RK73FB2A224J	CHIP R 220K J 1/10W	E5E6E7
R123			RK73FB2A104J	CHIP R 100K J 1/10W	E2E3E4	R142			RK73FB2A224J	CHIP R 220K J 1/10W	E8E9
R123			RK73FB2A104J	CHIP R 100K J 1/10W	E5E6E7	R142			RK73FB2A224J	CHIP R 220K J 1/10W	M3
R123			RK73FB2A104J	CHIP R 100K J 1/10W	E8E9	R143			RK73FB2A222J	CHIP R 2.2K J 1/10W	E2E3E4
R124			RK73FB2A103J	CHIP R 10K J 1/10W	E2E3E4	R143			RK73FB2A222J	CHIP R 2.2K J 1/10W	E5E6E7
R124			RK73FB2A103J	CHIP R 10K J 1/10W	E5E6E7	R143			RK73FB2A222J	CHIP R 2.2K J 1/10W	E8E9
R124			RK73FB2A103J	CHIP R 10K J 1/10W	E8E9	R143			RK73FB2A222J	CHIP R 2.2K J 1/10W	M3
R125			RK73FB2A152J	CHIP R 1.5K J 1/10W	E2E3E4	R144			RK73FB2A333J	CHIP R 33K J 1/10W	E2E3E4
R125			RK73FB2A152J	CHIP R 1.5K J 1/10W	E5E6E7	R144			RK73FB2A333J	CHIP R 33K J 1/10W	M3
R125			RK73FB2A152J	CHIP R 1.5K J 1/10W	E8E9	R145			RK73FB2A392J	CHIP R 3.9K J 1/10W	E2E3E4
R126			RK73FB2A562J	CHIP R 5.6K J 1/10W	M3	R145			RK73FB2A392J	CHIP R 3.9K J 1/10W	E5E6E7
R126			RK73FB2A562J	CHIP R 5.6K J 1/10W	E2E3E4	R145			RK73FB2A392J	CHIP R 3.9K J 1/10W	E8E9
R126			RK73FB2A562J	CHIP R 5.6K J 1/10W	E5E6E7	R145			RK73FB2A392J	CHIP R 3.9K J 1/10W	M3
R127			RK73FB2A103J	CHIP R 10K J 1/10W	E8E9	R146			RK73FB2A105J	CHIP R 1.0M J 1/10W	E2E3E4
R127			RK73FB2A103J	CHIP R 10K J 1/10W	E2E3E4	R146			RK73FB2A105J	CHIP R 1.0M J 1/10W	E5E6E7
R127			RK73FB2A103J	CHIP R 10K J 1/10W	E5E6E7	R146			RK73FB2A105J	CHIP R 1.0M J 1/10W	E8E9
R127			RK73FB2A103J	CHIP R 10K J 1/10W	E8E9	R146			RK73FB2A105J	CHIP R 1.0M J 1/10W	M3
R128			RK73FB2A153J	CHIP R 15K J 1/10W	E2E3E4	R147, 148			RK73FB2A222J	CHIP R 2.2K J 1/10W	E2E3E4
R128			RK73FB2A153J	CHIP R 15K J 1/10W	E5E6E7	R147, 148			RK73FB2A222J	CHIP R 2.2K J 1/10W	E5E6E7
R128			RK73FB2A153J	CHIP R 15K J 1/10W	E8E9	R147, 148			RK73FB2A222J	CHIP R 2.2K J 1/10W	E8E9
R129			RK73FB2A333J	CHIP R 33K J 1/10W	E2E3E4	R149, 150			RK73FB2A473J	CHIP R 47K J 1/10W	M3
R129			RK73FB2A333J	CHIP R 33K J 1/10W	E5E6E7	R149, 150			RK73FB2A473J	CHIP R 47K J 1/10W	E2E3E4
R129			RK73FB2A333J	CHIP R 33K J 1/10W	E8E9	R149, 150			RK73FB2A473J	CHIP R 47K J 1/10W	E5E6E7
R130			RK73FB2A562J	CHIP R 5.6K J 1/10W	E2E3E4	R149, 150			RK73FB2A473J	CHIP R 47K J 1/10W	E8E9
R130			RK73FB2A562J	CHIP R 5.6K J 1/10W	E5E6E7	R149, 150			RK73FB2A473J	CHIP R 47K J 1/10W	M3
R130			RK73FB2A562J	CHIP R 5.6K J 1/10W	E8E9	R151			RK73FB2A104J	CHIP R 100K J 1/10W	E2E3E4
R131			RK73FB2A272J	CHIP R 2.7K J 1/10W	E2E3E4	R151			RK73FB2A104J	CHIP R 100K J 1/10W	E5E6E7
R131			RK73FB2A272J	CHIP R 2.7K J 1/10W	E5E6E7	R151			RK73FB2A104J	CHIP R 100K J 1/10W	E8E9
R131			RK73FB2A272J	CHIP R 2.7K J 1/10W	E8E9	R151			RK73FB2A104J	CHIP R 100K J 1/10W	M3
R132			RK73FB2A823J	CHIP R 82K J 1/10W	E2E3E4	R155			RK73FB2A102J	CHIP R 1.0K J 1/10W	
R132			RK73FB2A823J	CHIP R 82K J 1/10W	E5E6E7	R156			RK73FB2A104J	CHIP R 100K J 1/10W	
R132			RK73FB2A823J	CHIP R 82K J 1/10W	E8E9	R157			RK73FB2A471J	CHIP R 470 J 1/10W	
R133			RK73FB2A220J	CHIP R 22 J 1/10W	E2E3E4	R158			RK73FB2A223J	CHIP R 22K J 1/10W	
R133			RK73FB2A220J	CHIP R 22 J 1/10W	E5E6E7	R159, 160			RK73FB2A471J	CHIP R 470 J 1/10W	
R133			RK73FB2A220J	CHIP R 22 J 1/10W	E8E9	R200			RK73FB2A102J	CHIP R 1.0K J 1/10W	
R134-137			RK73FB2A103J	CHIP R 10K J 1/10W	E2E3E4	R201			RD14DB2H332J	SMALL-RD 3.3K J 1/2W	
R134-137			RK73FB2A103J	CHIP R 10K J 1/10W	E5E6E7	R202			RK73FB2A472J	CHIP R 4.7K J 1/10W	KOK1K2
R134-137			RK73FB2A103J	CHIP R 10K J 1/10W	E8E9	R202			RK73FB2A472J	CHIP R 4.7K J 1/10W	M2M3

E: Europe K: North America M: Other Areas  
W: Without Europe  
△ indicates safety critical components.

E2: KRC-859R E5: KRC-859CY E8: KRC-759R  
E3: KRC-859RY E6: KRC-859W E9: KRC-759RY  
E4: KRC-859C E7: KRC-859WY

K0: KRC-PS955 M2: KRC-785  
K1: KRC-805 M3: KRC-885W  
K2: KRC-705

For Service Manuals Contact  
**MAURITRON TECHNICAL SERVICES**  
 8 Cherry Tree Rd, Chinnor  
 Oxon OX9 4QY  
 Tel: 01844-351694 Fax: 01844-352554  
 Email: enquires@mauritron.co.uk

# KRC-705/759R/RV/785/805/859C /CY/R/RV/WWY/885W/PS955

## PARTS LIST

SYNTHESIZER UNIT(X14-568X-XX)

\*New Parts  
 Parts without Parts No. are not supplied.  
 Les articles non mentionnes dans le Parts No. ne sont pas fournis.  
 Teile ohne Parts No. werden nicht geliefert.

Ref.No.	A d d	N e w	Parts No.	Description	Dest ination
R203			RK73FB2A123J	CHIP R 12K J 1/10W	
R204			RK73FB2A133J	CHIP R 13K J 1/10W	
R205			RK73EB2B104J	CHIP R 100K J 1/8W	
R206			RK73FB2A822J	CHIP R 8.2K J 1/10W	
R207			RK73FB2A473J	CHIP R 47K J 1/10W	KOK1K2
R207			RK73FB2A473J	CHIP R 47K J 1/10W	M2M3
R208			RK73FB2A163J	CHIP R 16K J 1/10W	
R209			R92-2023-05	CHIP R 820 J 1/2W	KOK1K2
R209			R92-2023-05	CHIP R 820 J 1/2W	M2M3
R210			RK73EB2B472J	CHIP R 4.7K J 1/8W	
R211			RK73FB2A223J	CHIP R 22K J 1/10W	
R212			RK73FB2A101J	CHIP R 100 J 1/10W	
R213			RK73FB2A681J	CHIP R 680 J 1/10W	
R214			RK73FB2A391J	CHIP R 390 J 1/10W	
R215			RK73FB2A472J	CHIP R 4.7K J 1/10W	
R217			RK73FB2A472J	CHIP R 4.7K J 1/10W	
R218			RK73FB2A122J	CHIP R 1.2K J 1/10W	
R219			RK73FB2A331J	CHIP R 330 J 1/10W	
R220			RK73FB2A332J	CHIP R 3.3K J 1/10W	
R221			RK73FB2A103J	CHIP R 10K J 1/10W	
R222			RK73EB2B101J	CHIP R 100 J 1/8W	
R223-227			RK73EB2B102J	CHIP R 1.0K J 1/8W	
R228, 229			RK73EB2B101J	CHIP R 100 J 1/8W	
R230-234			RK73FB2A104J	CHIP R 100K J 1/10W	
R235, 236			RK73EB2B100J	CHIP R 10 J 1/8W	
R237			RK73EB2B4R7J	CHIP R 4.7 J 1/8W	
R238			RK73FB2A471J	CHIP R 470 J 1/10W	
R239			RK73FB2A104J	CHIP R 100K J 1/10W	E2E3E8
R239			RK73FB2A104J	CHIP R 100K J 1/10W	E9
R239			RK73FB2A104J	CHIP R 100K J 1/10W	K2M2
R239, 240			RK73FB2A104J	CHIP R 100K J 1/10W	E4E5E6
R239, 240			RK73FB2A104J	CHIP R 100K J 1/10W	E7
R239, 240			RK73FB2A104J	CHIP R 100K J 1/10W	KOK1M3
R241			RK73FB2A4R7J	CHIP R 4.7 J 1/10W	E4E5E6
R241			RK73FB2A4R7J	CHIP R 4.7 J 1/10W	E7
R241			RK73FB2A4R7J	CHIP R 4.7 J 1/10W	KOK1M3
R242			RK73FB2A750J	CHIP R 75 J 1/10W	E4E5E6
R242			RK73FB2A750J	CHIP R 75 J 1/10W	E7
R242			RK73FB2A750J	CHIP R 75 J 1/10W	KOK1M3
R243			RK73FB2A102J	CHIP R 1.0K J 1/10W	E4E5E6
R243			RK73FB2A102J	CHIP R 1.0K J 1/10W	E7
R243			RK73FB2A102J	CHIP R 1.0K J 1/10W	KOK1M3
R244			RK73FB2A913J	CHIP R 91K J 1/10W	E4E5E6
R244			RK73FB2A913J	CHIP R 91K J 1/10W	E7
R244			RK73FB2A913J	CHIP R 91K J 1/10W	KOK1M3
R245			RK73FB2A470J	CHIP R 47 J 1/10W	E4E5E6
R245			RK73FB2A470J	CHIP R 47 J 1/10W	E7
R245			RK73FB2A470J	CHIP R 47 J 1/10W	KOK1M3
R246			RK73FB2A913J	CHIP R 91K J 1/10W	E4E5E6
R246			RK73FB2A913J	CHIP R 91K J 1/10W	E7
R246			RK73FB2A913J	CHIP R 91K J 1/10W	KOK1M3
R247			RK73FB2A103J	CHIP R 10K J 1/10W	E4E5E6
R247			RK73FB2A103J	CHIP R 10K J 1/10W	E7
R247			RK73FB2A103J	CHIP R 10K J 1/10W	KOK1M3
R248			RK73FB2A272J	CHIP R 2.7K J 1/10W	E4E5E6

Ref.No.	A d d	N e w	Parts No.	Description	Dest ination
R248			RK73FB2A272J	CHIP R 2.7K J 1/10W	E7
R248			RK73FB2A272J	CHIP R 2.7K J 1/10W	KOK1M3
R249			RK73FB2A563J	CHIP R 56K J 1/10W	E4E5E6
R249			RK73FB2A563J	CHIP R 56K J 1/10W	E7
R249			RK73FB2A563J	CHIP R 56K J 1/10W	KOK1M3
R250			RK73FB2A470J	CHIP R 47 J 1/10W	E4E5E6
R250			RK73FB2A470J	CHIP R 47 J 1/10W	E7
R250			RK73FB2A470J	CHIP R 47 J 1/10W	KOK1M3
R251			RK73FB2A913J	CHIP R 91K J 1/10W	E4E5E6
R251			RK73FB2A913J	CHIP R 91K J 1/10W	E7
R251			RK73FB2A913J	CHIP R 91K J 1/10W	KOK1M3
R252			RK73FB2A752J	CHIP R 7.5K J 1/10W	E4E5E6
R252			RK73FB2A752J	CHIP R 7.5K J 1/10W	E7
R252			RK73FB2A752J	CHIP R 7.5K J 1/10W	KOK1M3
R256			RK73FB2A104J	CHIP R 100K J 1/10W	
R257			RK73EB2B103J	CHIP R 10K J 1/8W	
R258			RK73FB2A752J	CHIP R 7.5K J 1/10W	E2E3E4
R258			RK73FB2A752J	CHIP R 7.5K J 1/10W	E5E6E7
R258			RK73FB2A752J	CHIP R 7.5K J 1/10W	E8E9
R259			RK73EB2B104J	CHIP R 100K J 1/8W	
R261			RK73FB2A100J	CHIP R 10 J 1/10W	E2E3E4
R261			RK73FB2A100J	CHIP R 10 J 1/10W	E5E6E7
R261			RK73FB2A100J	CHIP R 10 J 1/10W	E8E9
R261			RK73FB2A100J	CHIP R 10 J 1/10W	KOK1
R301			RK73FB2A103J	CHIP R 10K J 1/10W	
R302			RK73FB2A471J	CHIP R 470 J 1/10W	
R303			R92-0365-05	CHIP R 1.0K J 1/2W	
R304			RK73FB2A471J	CHIP R 470 J 1/10W	
R305			RK73FB2A104J	CHIP R 100K J 1/10W	
R306			RK73FB2A471J	CHIP R 470 J 1/10W	
R307			RK73FB2A122J	CHIP R 1.2K J 1/10W	
R309			RK73FB2A470J	CHIP R 47 J 1/10W	
R311			RK73FB2A104J	CHIP R 100K J 1/10W	
R312			RK73FB2A102J	CHIP R 1.0K J 1/10W	
R315, 316			R92-2104-05	CHIP R 2.2 J 1W	
R317			RK73FB2A223J	CHIP R 22K J 1/10W	E2E3E4
R317			RK73FB2A223J	CHIP R 22K J 1/10W	E5E6E7
R317			RK73FB2A223J	CHIP R 22K J 1/10W	E8E9
R318			RK73FB2A473J	CHIP R 47K J 1/10W	E2E3E4
R318			RK73FB2A473J	CHIP R 47K J 1/10W	E5E6E7
R318			RK73FB2A473J	CHIP R 47K J 1/10W	E8E9
R319			RK73FB2A102J	CHIP R 1.0K J 1/10W	E2E3E4
R319			RK73FB2A102J	CHIP R 1.0K J 1/10W	E5E6E7
R319			RK73FB2A102J	CHIP R 1.0K J 1/10W	E8E9
R321			RK73FB2A473J	CHIP R 47K J 1/10W	E4E5E6
R321			RK73FB2A473J	CHIP R 47K J 1/10W	E7E8E9
R321			RK73FB2A473J	CHIP R 47K J 1/10W	K1M2
R322			RK73FB2A473J	CHIP R 47K J 1/10W	KOM3
R322, 323			RK73FB2A473J	CHIP R 47K J 1/10W	E2E3
R322, 323			RK73FB2A473J	CHIP R 47K J 1/10W	K2
R323			RK73FB2A473J	CHIP R 47K J 1/10W	E8E9
R323			RK73FB2A473J	CHIP R 47K J 1/10W	M2
R324			RK73FB2A473J	CHIP R 47K J 1/10W	KOK1
R324, 325			RK73FB2A473J	CHIP R 47K J 1/10W	E4E5E6
R324, 325			RK73FB2A473J	CHIP R 47K J 1/10W	E7

E: Europe K: North America M: Other Areas  
 W: Without Europe  
 ⚡ indicates safety critical components.

E2: KRC-859R E5: KRC-859CY E8: KRC-759R K0: KRC-PS955 M2: KRC-785  
 E3: KRC-859RY E6: KRC-859W E9: KRC-759RY K1: KRC-805 M3: KRC-885W  
 E4: KRC-859C E7: KRC-859WY K2: KRC-705

# KRC-705/759R/R/RY/785/805/859C /CY/R/R/RY/W/WY/885W/PS955

For Service Manuals Contact  
MAURITRON TECHNICAL SERVICES  
8 Cherry Tree Rd, Chinnor  
Oxon OX9 4QY  
Tel: 01844-351694 Fax: 01844-350554  
Email: enquiries@mauritrondirect.com

\*New Parts

Parts without Parts No. are not supplied.

Les articles non mentionnés dans le Parts No. ne sont pas fournis.

Teile ohne Parts No. werden nicht geliefert.

## PARTS LIST

SYNTHESIZER UNIT(X14-568X-XX)

Ref.No.	A d d w	N e w	Parts No.	Description	Dest inati on	Ref.No.	A d d w	N e w	Parts No.	Description	Dest inati on
R324, 325			RK73FB2A473J	CHIP R 47K J 1/10W	M3	R389			RK73FB2A473J	CHIP R 47K J 1/10W	
R325			RK73FB2A473J	CHIP R 47K J 1/10W	E2E3E8	R406			RK73FB2A104J	CHIP R 100K J 1/10W	
R325			RK73FB2A473J	CHIP R 47K J 1/10W	E9	R407			RK73FB2A471J	CHIP R 470 J 1/10W	
R326			RK73FB2A473J	CHIP R 47K J 1/10W	KOK1K2	R409			RK73FB2A104J	CHIP R 100K J 1/10W	
R326			RK73FB2A473J	CHIP R 47K J 1/10W	M2	R415			RK73FB2A105J	CHIP R 1.0M J 1/10W	E2E3E4
R327-329			RK73FB2A472J	CHIP R 4.7K J 1/10W		R415			RK73FB2A105J	CHIP R 1.0M J 1/10W	E5E6E7
R330			RK73FB2A104J	CHIP R 100K J 1/10W		R415			RK73FB2A105J	CHIP R 1.0M J 1/10W	E8E9
R331			RK73FB2A222J	CHIP R 2.2K J 1/10W		R415			RK73FB2A105J	CHIP R 1.0M J 1/10W	M3
R332			RK73FB2A225J	CHIP R 2.2M J 1/10W		VR1, 2			R32-0211-05	SEMI FIXED VARIABLE RESISTOR	
R333			RK73FB2A102J	CHIP R 1.0K J 1/10W		VR3			R32-0229-05	SEMI FIXED VARIABLE RESISTOR	E2E3E4
R334			RK73FB2A472J	CHIP R 4.7K J 1/10W		VR3			R32-0229-05	SEMI FIXED VARIABLE RESISTOR	E5E6E7
R335			RK73FB2A104J	CHIP R 100K J 1/10W		VR3			R32-0229-05	SEMI FIXED VARIABLE RESISTOR	E8E9
R336, 337			RK73FB2A562J	CHIP R 5.6K J 1/10W		VR3			R32-0229-05	SEMI FIXED VARIABLE RESISTOR	M3
R338			RK73FB2A104J	CHIP R 100K J 1/10W		W9 -14			R92-2052-05	CHIP R 0 J 1/10W	E8E9
R340			RK73FB2A222J	CHIP R 2.2K J 1/10W		W9 -14			R92-2052-05	CHIP R 0 J 1/10W	K1K2M2
R341, 342			RK73FB2A102J	CHIP R 1.0K J 1/10W		W9 -14			R92-2052-05	CHIP R 0 J 1/10W	M3
R343			RK73FB2A472J	CHIP R 4.7K J 1/10W		W17 -20			R92-2052-05	CHIP R 0 J 1/10W	E8E9
R344			RK73FB2A222J	CHIP R 2.2K J 1/10W		W17 -20			R92-2052-05	CHIP R 0 J 1/10W	K1K2M2
R345-347			RK73FB2A472J	CHIP R 4.7K J 1/10W		W17 -20			R92-2052-05	CHIP R 0 J 1/10W	M3
R348			RK73FB2A684J	CHIP R 680K J 1/10W		W30			R92-2052-05	CHIP R 0 J 1/10W	KOK1K2
R350			RK73FB2A222J	CHIP R 2.2K J 1/10W	E2E3E4	W30			R92-2052-05	CHIP R 0 J 1/10W	M2
R350			RK73FB2A222J	CHIP R 2.2K J 1/10W	E5E6E7	W32			R92-2052-05	CHIP R 0 J 1/10W	KOK1K2
R350			RK73FB2A222J	CHIP R 2.2K J 1/10W	E8E9	W32			R92-2052-05	CHIP R 0 J 1/10W	M2
R350			RK73FB2A222J	CHIP R 2.2K J 1/10W	KOK1	W33			R92-2052-05	CHIP R 0 J 1/10W	E2E3E4
R351			RK73FB2A104J	CHIP R 100K J 1/10W	K2M2	W33			R92-2052-05	CHIP R 0 J 1/10W	E5E6E7
R351			RK73FB2A104J	CHIP R 100K J 1/10W	M3	W33			R92-2052-05	CHIP R 0 J 1/10W	E8E9
R352			RK73FB2A164J	CHIP R 160K J 1/10W		W100			R92-2052-05	CHIP R 0 J 1/10W	
R353-356			RK73FB2A102J	CHIP R 1.0K J 1/10W		W102-105			R92-2052-05	CHIP R 0 J 1/10W	M3
R357			RK73FB2A472J	CHIP R 4.7K J 1/10W	KOK1K2	W102-106			R92-2052-05	CHIP R 0 J 1/10W	KOK1K2
R357			RK73FB2A472J	CHIP R 4.7K J 1/10W	M2M3	W102-106			R92-2052-05	CHIP R 0 J 1/10W	M2
R357, 358			RK73FB2A472J	CHIP R 4.7K J 1/10W	E2E3E4	W104, 105			R92-2052-05	CHIP R 0 J 1/10W	E2E3E4
R357, 358			RK73FB2A472J	CHIP R 4.7K J 1/10W	E5E6E7	W104, 105			R92-2052-05	CHIP R 0 J 1/10W	E5E6E7
R357, 358			RK73FB2A472J	CHIP R 4.7K J 1/10W	E8E9	W104, 105			R92-2052-05	CHIP R 0 J 1/10W	E8E9
R360			RK73FB2A223J	CHIP R 22K J 1/10W		PH1			T95-0231-05	OPTO ISOLATOR	
R365			RK73FB2A472J	CHIP R 4.7K J 1/10W	E2E3E4	D1, 2			DA204K	DIODE	
R365			RK73FB2A472J	CHIP R 4.7K J 1/10W	E5E6E7	D3			MA3062WA	ZENER DIODE	
R365			RK73FB2A472J	CHIP R 4.7K J 1/10W	E8E9	D5, 6			DAP202K	DIODE	
R367			RK73FB2A472J	CHIP R 4.7K J 1/10W	M3	D5, 6			MA152WA	DIODE	
R368, 369			RK73FB2A102J	CHIP R 1.0K J 1/10W		D7, 8			DA204K	DIODE	
R371			RK73FB2A102J	CHIP R 1.0K J 1/10W		D121			DAP202K	DIODE	E2E3E4
R373, 374			RK73FB2A102J	CHIP R 1.0K J 1/10W		D121			DAP202K	DIODE	E5E6E7
R375			RK73FB2A154J	CHIP R 150K J 1/10W		D121			DAP202K	DIODE	E8E9
R376-378			RK73FB2A222J	CHIP R 2.2K J 1/10W		D121			MA152WA	DIODE	E2E3E4
R379, 380			RK73FB2A472J	CHIP R 4.7K J 1/10W	E2E3E4	D121			MA152WA	DIODE	E5E6E7
R379, 380			RK73FB2A472J	CHIP R 4.7K J 1/10W	E5E6E7	D121			MA152WA	DIODE	E8E9
R379, 380			RK73FB2A472J	CHIP R 4.7K J 1/10W	E8E9	D142			HZM6.8N(B2)	ZENER DIODE	
R379, 380			RK73FB2A472J	CHIP R 4.7K J 1/10W	M3	D142			MA3068-M	ZENER DIODE	
R382			RK73FB2A472J	CHIP R 4.7K J 1/10W	KOK1K2	D143			HZM7.5N(B2)	ZENER DIODE	
R382			RK73FB2A472J	CHIP R 4.7K J 1/10W	M2M3	D143			MA3075-M	ZENER DIODE	
R382, 383			RK73FB2A472J	CHIP R 4.7K J 1/10W	E2E3E4	D198, 199	*		D1CA60R	DIODE	
R382, 383			RK73FB2A472J	CHIP R 4.7K J 1/10W	E5E6E7	D200			OAN202K	DIODE	
R382, 383			RK73FB2A472J	CHIP R 4.7K J 1/10W	E8E9	D200			MA152WK	DIODE	
R384			RK73FB2A472J	CHIP R 4.7K J 1/10W	KO	D201			RM10ZLF	DIODE	
R387			RK73FB2A473J	CHIP R 47K J 1/10W		D202			RD6.8M(B2)	ZENER DIODE	

E: Europe K: North America M: Other Areas  
W: Without Europe

△ indicates safety critical components.

E2: KRC-859R E5: KRC-859CY E8: KRC-759R K0: KRC-PS955 M2: KRC-785  
E3: KRC-859RY E6: KRC-859W E9: KRC-759RY K1: KRC-805 M3: KRC-885W  
E4: KRC-859C E7: KRC-859WY K2: KRC-705

For Service Manuals Contact  
**MAURITRON TECHNICAL SERVICES**  
 8 Cherry Tree Rd, Chinnor  
 Oxon OX9 4QY  
 Tel: 01844-351694 Fax: 01844-352554  
 Email: enquiries@mauritron.co.uk

# KRC-705/759R/R/RY/785/805/859C /CY/R/R/RY/W/WY/885W/PS955

## PARTS LIST

SYNTHESIZER UNIT(X14-568X-XX)

\*New Parts

Parts without Parts No. are not supplied.

Les articles non mentionnés dans le Parts No. ne sont pas fournis.

Teile ohne Parts No. werden nicht geliefert.

Ref.No.	A d d w	N e w	Parts No.	Description	Dest inati on	Ref.No.	A d d w	N e w	Parts No.	Description	Dest inati on
D203			AM01Z	DIODE	KOK1K2	IC10			TC7660SEOA	ANALOGUE IC	KOK1M3
D203			AM01Z	DIODE	M2M3	IC11, 12			NJM4565M-TE2	ANALOGUE IC	E4E5E6
D204			RD6.8M(B2)	ZENER DIODE		IC11, 12			NJM4565M-TE2	ANALOGUE IC	E7
D205			M1F60	DIODE		IC11, 12			NJM4565M-TE2	ANALOGUE IC	KOK1M3
D206			DAN202K	DIODE		IC13			HA12163FP	ANALOGUE IC	E2E3E4
D206			MA152WK	DIODE		IC13			HA12163FP	ANALOGUE IC	E5E6E7
D207			AM01Z	DIODE		IC13			HA12163FP	ANALOGUE IC	E8E9
D208			DAP202K	DIODE		IC13			HA12163FP	ANALOGUE IC	K1K2M2
D208			MA152WA	DIODE		IC13			HA12163FP	ANALOGUE IC	M3
D210			1SS181	DIODE		IC13			HA12173FP	ANALOGUE IC	K0
D211			AM01Z	DIODE		IC14			TDA7435	ANALOGUE IC	E2E3E4
D212			DAP202K	DIODE		IC14			TDA7435	ANALOGUE IC	E5E6E7
D212			MA152WA	DIODE		IC14			TDA7435	ANALOGUE IC	K0
D231-233			MA3062WA	ZENER DIODE		IC15			KKZ06F	CUSTOM IC	
D234			MA3062-M	ZENER DIODE		IC16			TC74HC02AF	IC	
D235			DAP202K	DIODE		IC18			NJM2903M	IC(COMPARATOR X2)	E2E3E4
D235			MA152WA	DIODE		IC18			NJM2903M	IC(COMPARATOR X2)	E5E6E7
D241	*		HZM11N(B1)	ZENER DIODE	E4E5E6	IC18			NJM2903M	IC(COMPARATOR X2)	E8E9
D241	*		HZM11N(B1)	ZENER DIODE	E7	IC18			NJM2903M	IC(COMPARATOR X2)	M3
D241	*		HZM11N(B1)	ZENER DIODE	KOK1M3	IC20			PST9130NR	ANALOGUE IC	
D241			MA3110-L	ZENER DIODE	E4E5E6	Q1 -4			2SD2114K	TRANSISTOR	
D241			MA3110-L	ZENER DIODE	E7	Q10			DTA144EK	DIGITAL TRANSISTOR	
D241			MA3110-L	ZENER DIODE	KOK1M3	Q10			UN2113	DIGITAL TRANSISTOR	
D242	*		HZM5.6N(B2)	ZENER DIODE	E4E5E6	Q11			DTC144EK	DIGITAL TRANSISTOR	
D242	*		HZM5.6N(B2)	ZENER DIODE	E7	Q11			UN2213	DIGITAL TRANSISTOR	
D242	*		HZM5.6N(B2)	ZENER DIODE	KOK1M3	Q90			DTC124EK	DIGITAL TRANSISTOR	
D242			MA3056-M	ZENER DIODE	E4E5E6	Q90			UN2212	DIGITAL TRANSISTOR	
D242			MA3056-M	ZENER DIODE	E7	Q121			2SC2412K	TRANSISTOR	E2E3E4
D242			MA3056-M	ZENER DIODE	KOK1M3	Q121			2SC2412K	TRANSISTOR	E5E6E7
D250	*		DSP-301N-A21F	SURGE ABSORBER	KOK1M3	Q121			2SC2412K	TRANSISTOR	E8E9
D300			DAN202K	DIODE		Q121			2SD601A	TRANSISTOR	E2E3E4
D300			MA152WK	DIODE		Q121			2SD601A	TRANSISTOR	E5E6E7
D301			AM01Z	DIODE		Q121			2SD601A	TRANSISTOR	E8E9
D302	*		HZM22N(B3)	ZENER DIODE		Q122			DTC114TK	DIGITAL TRANSISTOR	E2E3E4
D302			MA3220-H	ZENER DIODE		Q122			DTC114TK	DIGITAL TRANSISTOR	E5E6E7
D303	*		HZM4.7N(B2)	ZENER DIODE	E2E3E4	Q122			DTC114TK	DIGITAL TRANSISTOR	E8E9
D303	*		HZM4.7N(B2)	ZENER DIODE	E5E6E7	Q122			UN2215	DIGITAL TRANSISTOR	E2E3E4
D303	*		HZM4.7N(B2)	ZENER DIODE	E8E9	Q122			UN2215	DIGITAL TRANSISTOR	E5E6E7
D303			MA3047-M	ZENER DIODE	E2E3E4	Q122			UN2215	DIGITAL TRANSISTOR	E8E9
D303			MA3047-M	ZENER DIODE	E5E6E7	Q123			DTA124EK	DIGITAL TRANSISTOR	E2E3E4
D303			MA3047-M	ZENER DIODE	E8E9	Q123			DTA124EK	DIGITAL TRANSISTOR	E5E6E7
IC1	*		UPD784215GF522	MI-COM IC		Q123			DTA124EK	DIGITAL TRANSISTOR	E8E9
IC2			TDA7461D	ANALOGUE IC		Q123			UN2112	DIGITAL TRANSISTOR	E2E3E4
IC3			NJM4565M-TE2	ANALOGUE IC	E2E3E4	Q123			UN2112	DIGITAL TRANSISTOR	E5E6E7
IC3			NJM4565M-TE2	ANALOGUE IC	E5E6E7	Q123			UN2112	DIGITAL TRANSISTOR	E8E9
IC3			NJM4565M-TE2	ANALOGUE IC	E8E9	Q139, 140			DTC143TK	DIGITAL TRANSISTOR	E2E3E4
IC6			TDA7386	ANALOGUE IC		Q139, 140			DTC143TK	DIGITAL TRANSISTOR	E5E6E7
IC7			BA3917-V4	ANALOGUE IC		Q139, 140			DTC143TK	DIGITAL TRANSISTOR	E8E9
IC8	*		TDA7479D	ANALOGUE IC	E2E3E4	Q139, 140			DTC143TK	DIGITAL TRANSISTOR	M3
IC8	*		TDA7479D	ANALOGUE IC	E5E6E7	Q139, 140			UN2216	DIGITAL TRANSISTOR	E2E3E4
IC8	*		TDA7479D	ANALOGUE IC	E8E9	Q139, 140			UN2216	DIGITAL TRANSISTOR	E5E6E7
IC8	*		TDA7479D	ANALOGUE IC	KOK1	Q139, 140			UN2216	DIGITAL TRANSISTOR	E8E9
IC9			BA6238A	ANALOGUE IC		Q139, 140			UN2216	DIGITAL TRANSISTOR	M3
IC10			TC7660SEOA	ANALOGUE IC	E4E5E6	Q141			DTC124TK	DIGITAL TRANSISTOR	E2E3E4
IC10			TC7660SEOA	ANALOGUE IC	E7	Q141			DTC124TK	DIGITAL TRANSISTOR	E5E6E7

E: Europe K: North America M: Other Areas  
 W: Without Europe

△ indicates safety critical components.

E2: KRC-859R E5: KRC-859CY E8: KRC-759R K0: KRC-PS955 M2: KRC-785  
 E3: KRC-859RY E6: KRC-859W E9: KRC-759RY K1: KRC-805 M3: KRC-885W  
 E4: KRC-859C E7: KRC-859WY K2: KRC-705

# KRC-705/759R/R/785/805/859C /CY/R/R/W/WY/885W/PS955

For Service Manuals Contact  
**MAURITRON TECHNICAL SERVICES**  
 8 Cherry Tree Industrial Estate  
 Oxon OX9 4DQ  
 Tel: 01844-351691 Fax: 01844-351694  
 Email: enquiries@mauritron.co.uk

## PARTS LIST

\*New Parts

Parts without Parts No. are not supplied.

Les articles non mentionnes dans le Parts No. ne sont pas fournis.

Teile ohne Parts No. werden nicht geliefert.

### SYNTHESIZER UNIT(X14-568X-XX)

Ref.No.	A d	N d w	Parts No.	Description	Dest inati on	Ref.No.	A d	N d w	Parts No.	Description	Dest inati on
Q141			DTC124TK	DIGITAL TRANSISTOR	E8E9	Q246-248			2SD601A	TRANSISTOR	E4E5E6
Q141			DTC124TK	DIGITAL TRANSISTOR	M3	Q246-248			2SD601A	TRANSISTOR	E7
Q141			UN2217	DIGITAL TRANSISTOR	E2E3E4	Q246-248			2SD601A	TRANSISTOR	KOK1M3
Q141			UN2217	DIGITAL TRANSISTOR	E5E6E7	Q249, 250			2SA1037K	TRANSISTOR	E4E5E6
Q141			UN2217	DIGITAL TRANSISTOR	E8E9	Q249, 250			2SA1037K	TRANSISTOR	E7
Q141			UN2217	DIGITAL TRANSISTOR	M3	Q249, 250			2SA1037K	TRANSISTOR	KOK1M3
Q151			DTC124EK	DIGITAL TRANSISTOR		Q301			2SB1443	TRANSISTOR	
Q151			UN2212	DIGITAL TRANSISTOR		Q302			DTC114YK	DIGITAL TRANSISTOR	
Q199			DTC144EK	DIGITAL TRANSISTOR		Q302			UN2214	DIGITAL TRANSISTOR	
Q199			UN2213	DIGITAL TRANSISTOR		Q303			2SB1184	TRANSISTOR	
Q202			2SB1277(Q, R)	TRANSISTOR	KOK1K2	Q304			2SB1443	TRANSISTOR	
Q202			2SB1277(Q, R)	TRANSISTOR	M2M3	Q305			2SC2412K	TRANSISTOR	
Q204			DTC114YK	DIGITAL TRANSISTOR	KOK1K2	Q305			2SD601A	TRANSISTOR	
Q204			DTC114YK	DIGITAL TRANSISTOR	M2M3	Q306			DTA124EK	DIGITAL TRANSISTOR	
Q204			UN2214	DIGITAL TRANSISTOR	KOK1K2	Q306			UN2112	DIGITAL TRANSISTOR	
Q204			UN2214	DIGITAL TRANSISTOR	M2M3	Q307			2SC2412K	TRANSISTOR	
Q205, 206			2SC2412K	TRANSISTOR		Q307			2SD601A	TRANSISTOR	
Q205, 206			2SD601A	TRANSISTOR		Q308			DTC144EK	DIGITAL TRANSISTOR	
Q207			2SD1760	TRANSISTOR		Q308			UN2213	DIGITAL TRANSISTOR	
Q208			DTA124EK	DIGITAL TRANSISTOR		Q311			DTC144EK	DIGITAL TRANSISTOR	
Q208			UN2112	DIGITAL TRANSISTOR		Q311			UN2213	DIGITAL TRANSISTOR	
Q209			2SA1037K	TRANSISTOR		Q323			DTC144EK	DIGITAL TRANSISTOR	E2E3E4
Q210			DTA114YK	DIGITAL TRANSISTOR		Q323			DTC144EK	DIGITAL TRANSISTOR	E5E6E7
Q210			UN2114	DIGITAL TRANSISTOR		Q323			DTC144EK	DIGITAL TRANSISTOR	E8E9
Q211			DTC144EK	DIGITAL TRANSISTOR		Q323			UN2213	DIGITAL TRANSISTOR	E2E3E4
Q211			UN2213	DIGITAL TRANSISTOR		Q323			UN2213	DIGITAL TRANSISTOR	E5E6E7
Q231			DTA124EK	DIGITAL TRANSISTOR		Q323			UN2213	DIGITAL TRANSISTOR	E8E9
Q231			UN2112	DIGITAL TRANSISTOR		Q324			DTD123YK	DIGITAL TRANSISTOR	E2E3E4
Q241			2SC2412K	TRANSISTOR	E4E5E6	Q324			DTD123YK	DIGITAL TRANSISTOR	E5E6E7
Q241			2SC2412K	TRANSISTOR	E7	Q324			DTD123YK	DIGITAL TRANSISTOR	E8E9
Q241			2SC2412K	TRANSISTOR		Q324			DTD123YK	DIGITAL TRANSISTOR	M3
Q241			2SD601A	TRANSISTOR	KOK1M3	Q324			* UN2224	DIGITAL TRANSISTOR	E2E3E4
Q241			2SD601A	TRANSISTOR	E4E5E6	Q324			* UN2224	DIGITAL TRANSISTOR	E5E6E7
Q241			2SD601A	TRANSISTOR	E7	Q324			* UN2224	DIGITAL TRANSISTOR	E8E9
Q241			2SB1443	TRANSISTOR	E4E5E6	Q324			* UN2224	DIGITAL TRANSISTOR	M3
Q242			2SB1443	TRANSISTOR	E7	TH1			PT722A80C	POSITIVE RESISTOR	
Q242			2SB1443	TRANSISTOR	KOK1M3	A1			* W02-3119-05	FM/AM FRONT-END	KOK1K2
Q243			DTA114EK	DIGITAL TRANSISTOR	E4E5E6	A1			* W02-3119-05	FM/AM FRONT-END	M2
Q243			DTA114EK	DIGITAL TRANSISTOR	E7	A1			* W02-3123-05	FM/AM FRONT-END	E2E3E4
Q243			DTA114EK	DIGITAL TRANSISTOR	KOK1M3	A1			* W02-3123-05	FM/AM FRONT-END	E5E6E7
Q243			UN2111	DIGITAL TRANSISTOR	E4E5E6	A1			* W02-3123-05	FM/AM FRONT-END	E8E9
Q243			UN2111	DIGITAL TRANSISTOR	E7	A1			* W02-3123-05	FM/AM FRONT-END	E8E9
Q243			UN2111	DIGITAL TRANSISTOR	KOK1M3	A1			* W02-3123-05	FM/AM FRONT-END	M3
Q244			DTC144EK	DIGITAL TRANSISTOR	E4E5E6	<b>CASSETTE MECHANISM ASSY(D40-1082-15)</b>					
Q244			DTC144EK	DIGITAL TRANSISTOR	E7						
Q244			DTC144EK	DIGITAL TRANSISTOR	KOK1M3	1	2A		A10-4329-08	CHASSIS ASSY	
Q244			UN2213	DIGITAL TRANSISTOR	E4E5E6	2	1A		J21-7779-08	HEAD MOUNTING HARDWARE ASSY	
Q244			UN2213	DIGITAL TRANSISTOR	E7	3	2B		A11-0931-08	SUB CHASSIS ASSY	
Q244			UN2213	DIGITAL TRANSISTOR	KOK1M3	4	1A		D10-4106-08	ARM	
Q245			2SA1037K	TRANSISTOR	E4E5E6	5	2A		D10-4107-08	ARM	
Q245			2SA1037K	TRANSISTOR	E7	6	2A		D10-4108-08	ARM	
Q245			2SA1037K	TRANSISTOR	KOK1M3	7	2B		D10-4109-08	ARM	
Q246-248			2SC2412K	TRANSISTOR	E4E5E6	8	2A		D10-4110-08	ARM ASSY	
Q246-248			2SC2412K	TRANSISTOR	E7	9	2A		D10-4111-08	ARM ASSY	
Q246-248			2SC2412K	TRANSISTOR	KOK1M3	10	3A		D10-4112-08	ARM	

E: Europe K: North America M: Other Areas  
 W: Without Europe  
 ⚠ indicates safety critical components.

E2: KRC-859R E5: KRC-859CY E8: KRC-759R K0: KRC-PS955 M2: KRC-785  
 E3: KRC-859RY E6: KRC-859W E9: KRC-759RY K1: KRC-805 M3: KRC-885W  
 E4: KRC-859C E7: KRC-859WY K2: KRC-705



For Service Manuals Contact  
**MAURITRON TECHNICAL SERVICES**  
 8 Cherry Tree Rd, Chinnor  
 Oxon OX9 4QY  
 Tel: 01844-351694 Fax: 01844-352554  
 Email: enquiries@mauriton.co.uk

# KRC-705/759R/R/RY/785/805/859C /CY/R/R/RY/W/WY/885W/PS955

## PARTS LIST

\*New Parts  
 Parts without Parts No. are not supplied.  
 Les articles non mentionnes dans le Parts No. ne sont pas fournis.  
 Teile ohne Parts No. werden nicht geliefert.

Ref.No.	A d d w	N e w	Parts No.	Description	Dest inati on
13	2A		D10-4113-08	ARM	
14	1B		D13-1324-08	GEAR ASSY	
15	3A		D01-0609-08	FLYWHEEL ASSY	
16	2A		D13-1325-08	GEAR ASSY	
17	2A		D10-4114-08	ARM ASSY	
18	3A		D01-0610-08	FLYWHEEL ASSY	
19	3A		D13-1326-08	GEAR ASSY	
22	2B		D10-4115-08	SLIDER	
23	3B		D10-4116-08	SLIDER	
24	1B		J21-7780-08	MOTOR MOUNTING HARDWARE	
25	1B		D10-4117-08	ARM	
26	1B		D10-4118-08	SLIDER	
27	1A		A52-0716-08	CASSETTE HOLDER	
32	1B		J90-0767-08	GUID	
33	1B		J19-4737-08	BRACKET	
34	1B		D12-0622-08	CAM	
35	2B		D13-1327-08	GEAR	
36	2B		D13-1328-08	GEAR	
37	3A		D13-1329-08	GEAR	
38	3A		D10-4119-08	ARM	
39	1B		D13-1330-08	GEAR	
40	2A		D13-1331-08	GEAR	
41	2A		D13-1332-08	GEAR	
42	3B		J11-0619-08	CLAMPER	
43	1B		D13-1333-08	GEAR	
44	1B		D13-1334-08	GEAR	
45	2A		D13-1335-08	GEAR	
46	2B		D10-4120-08	ARM	
47	2B		J19-4738-08	HOLDER	
48	2B		J11-0620-08	CLAMPER	
52	2A		D03-0312-08	REEL CAP	
53	3B		D15-0913-08	PULLEY	
54	1B		D13-1336-08	WORM	
55	1A		D10-4121-08	SLIDER	
56	2A	*	D10-4122-08	ARM	
57	1B		D13-1337-08	GEAR	
59	2B		J31-1036-08	COLLAR	
62	3B		D14-0683-08	ROLLER	
63	1A		D14-0684-08	ROLLER	
64	2A		D15-0914-08	PULLEY	
67	2A		G01-2832-08	TORSION COIL SPRING	
68	2A		G01-2833-08	TORSION COIL SPRING	
69	2B		G01-2834-08	TENSION COIL SPRING	
70	1B		G01-2835-08	TORSION COIL SPRING	
71	1B		G01-2836-08	TORSION COIL SPRING	
73	1A		G09-2020-08	SPRING	
74	2A		G01-2837-08	COMPRESSION SPRING	
75	1B		G01-2838-08	TORSION COIL SPRING	
76	1A		G01-2839-08	TORSION COIL SPRING	
77	2B		G01-2843-08	TORSION COIL SPRING	
79	1A		G01-2840-08	TENSION COIL SPRING	
80	3A		G01-2841-08	TENSION COIL SPRING	
81	2A	*	G01-2842-08	TORSION COIL SPRING	
83	3A		D16-0609-08	BELT	
94	3A		S64-0804-08	LEVER SWITCH	

Ref.No.	A d d w	N e w	Parts No.	Description	Dest inati on
95	3A		S64-0805-08	LEVER SWITCH	
100	2B		E30-4460-08	CONNECTOR ASSY(10P)	
102	2B		T95-0213-08	PHOTO COUPLER	
103	2B		S62-0858-08	SLIDE SWITCH	
105	2B		S74-0813-08	LEAF SWITCH	
107	3A		E30-4468-08	CONNECTOR ASSY(7P)	
A	1B		N09-4193-08	SCREW	
B	1B		N09-4194-08	SCREW	
C	1A		N09-4195-08	SCREW	
D	1B		N09-4196-08	SCREW	
E	2A		N09-4197-08	SCREW	
F	1B		N09-4198-08	SCREW	
G	1A		N09-4199-08	SCREW	
H	2B		N09-4200-08	SCREW	
HD1	1B		T31-0220-08	PLAYBACK HEAD	
J	3B		N09-4201-08	SCREW	
K	2A		N19-2086-08	FLAT WASHER	
L	3A		N19-2087-08	FLAT WASHER	
M	3A		N19-2088-08	FLAT WASHER	
M1	1A		T42-0759-08	MAIN MOTOR	
M2	1B		T42-0755-08	MOTOR ASSY	
N	1B		N19-2089-08	FLAT WASHER	
P	3A		N19-2090-08	FLAT WASHER	
Q	2A		N19-2091-08	FLAT WASHER	
R	1A		N19-2092-08	FLAT WASHER	
S	2B		N29-0510-08	RETAINING RING	
T	3A		N29-0511-08	RETAINING RING	

E: Europe K: North America M: Other Areas  
 W: Without Europe  
 ▲ indicates safety critical components.

E2: KRC-859R E5: KRC-859CY E8: KRC-759R K0: KRC-PS955 M2: KRC-785  
 E3: KRC-859RY E6: KRC-859W E9: KRC-759RY K1: KRC-805 M3: KRC-885W  
 E4: KRC-859C E7: KRC-859WY K2: KRC-705

# KRC-705/759R/R/RY/785/805/859C /CY/R/R/RY/W/WY/885W/PS955

## PARTS LIST

### CAPACITORS

CC 45 TH 1H 220 J  
1 2 3 4 5 6

- 1 = Type ... ceramic, electrolytic, etc.
- 2 = Shape ... round, square, ect.
- 3 = Temp. coefficient
- 4 = Voltage rating
- 5 = Value
- 6 = Tolerance

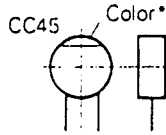

#### Capacitor value

- 010 = 1pF
- 100 = 10pF
- 101 = 100pF
- 102 = 1000pF = 0.001µF
- 103 = 0.01µF

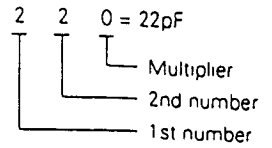

#### Temperature coefficient

1st Word	C	L	P	R	S	T	U
Color*	Black	Red	Orange	Yellow	Green	Blue	Violet
ppm/°C	0	-80	-150	-220	-330	-470	-750

2nd Word	G	H	J	K	L
ppm/°C	±30	±60	±120	±250	±500

Example: CC45TH = -470 ± 60ppm/°C

#### Tolerance (More than 10pF)

Code	C	D	G	J	K	M	X	Z	P	No code
(%)	±0.25	±0.5	±2	±5	±10	±20	+40 -20	+80 -20	+100 -0	More than 10µF -10 - +50 Less than 4.7µF -10 - +75

#### (Less than 10pF)

Code	B	C	D	F	G
(pF)	±0.1	±0.25	±0.5	±1	±2

#### Voltage rating

2nd word	A	B	C	D	E	F	G	H	J	K	V	
1st word	0	1.0	1.25	1.6	2.0	2.5	3.15	4.0	5.0	6.3	8.0	-
1	10	12.5	16	20	25	31.5	40	50	63	80	35	-
2	100	125	160	200	250	315	400	500	630	800	-	-
3	1000	1250	1600	2000	2500	3150	4000	5000	6300	8000	-	-

#### Chip capacitors

(EX) C C 7 3 F S L 1 H 0 0 0 J  
1 2 3 4 5 6 7

(Chip) (CH, RH, UJ, SL)

(EX) C K 7 3 F F 1 H 0 0 0 Z  
1 2 3 4 5 6 7

(Chip) (B, F)

Refer to the table above.

- 1 = Type
- 2 = Shape
- 3 = Dimension
- 4 = Temp coefficient
- 5 = Voltage rating
- 6 = Value
- 7 = Tolerance

#### Dimension (Chip capacitors)

Dimension code	L	W	T
Empty	5.6 ± 0.5	5.0 ± 0.5	Less than 2.0
A	4.5 ± 0.5	3.2 ± 0.4	Less than 2.0
B	4.5 ± 0.5	2.0 ± 0.3	Less than 2.0
C	4.5 ± 0.5	1.25 ± 0.2	Less than 1.25
D	3.2 ± 0.4	2.5 ± 0.3	Less than 1.5
E	3.2 ± 0.2	1.6 ± 0.2	Less than 1.25
F	2.0 ± 0.3	1.25 ± 0.2	Less than 1.25
G	1.6 ± 0.2	0.8 ± 0.2	Less than 1.0

### RESISTORS

#### Chip resistor (Carbon)

(EX) R K 7 3 E B 2 B 0 0 0 J  
1 2 3 4 5 6 7

(Chip) (B, F)

#### Carbon resistor (Normal type)

(EX) R D 1 4 B B 2 C 0 0 0 J  
1 2 3 4 5 6 7

- 1 = Type
- 2 = Shape
- 3 = Dimension
- 4 = Temp coefficient
- 5 = Rating wattage
- 6 = Value
- 7 = Tolerance

#### Dimension

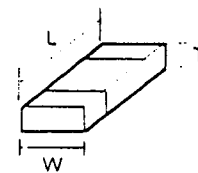

#### Dimension (Chip resistor)

Dimension code	L	W	T
E	3.2 ± 0.2	1.6 ± 0.2	1.0
F	2.0 ± 0.3	1.25 ± 0.2	1.0
G	1.6 ± 0.2	0.8 ± 0.2	0.5 ± 0.1

#### Rating wattage

Code	Wattage	Code	Wattage	Code	Wattage
1J	1/16W	2C	1/6W	3A	1W
2A	1/10W	2E	1/4W	3D	2W
2S	1/8W	2H	1/2W		

For Service Manuals Contact  
MAURITRON TECHNICAL SERVICES  
8 Cherry Tree Rd, Chinnor  
Oxon OX9 4QY  
Tel: 01844-351694 Fax: 01844-352554  
Email: enquiries@mauritron.co.uk

For Service Manuals Contact  
MAURITRON TECHNICAL SERVICES  
8 Cherry Tree Rd, Chinnor  
Oxon OX9 4QY  
Tel: 01844-351694 Fax: 01844-352554  
Email: enquiries@mauritron.co.uk

For Service Manuals Contact  
**MAURITRON TECHNICAL SERVICES**  
 8 Cherry Tree Rd, Chinnor  
 Oxon OX9 4QY  
 Tel: 01844-351694 Fax: 01844-352554  
 Email: enquiries@mauritron.co.uk

# KRC-705/759R/RV/785/805/859C /CY/R/RV/W/WY/885W/PS955

## SPECIFICATIONS

### KRC-PS955, KRC-805, KRC-705

#### FM Tuner section

Frequency range ..... 87.9 - 107.9 MHz  
 Channel space selection ..... 50k/200 kHz  
 Usable sensitivity (S/N=30dB) ..... 9.3 dBf (0.8  $\mu$  V/75  $\Omega$ )  
 Quieting Sensitivity (S/N=50dB) ..... 15.2 dBf (1.6  $\mu$  V/75  $\Omega$ )  
 Frequency response ( $\pm 3.0$ dB) ..... 30 Hz - 15kHz  
 Signal to Noise ratio (MONO) ..... 70 dB  
 Selectivity ( $\pm 400$ kHz) .....  $\geq 80$  dB  
 Stereo separation (1 kHz) ..... 40 dB

#### AM Tuner section

Frequency range ..... 530 - 1700 kHz  
 Channel space selection ..... 9k/10 kHz  
 Usable sensitivity (S/N 20dB) ..... 28 dB  $\mu$  (25  $\mu$  v)

#### Cassette Player section

Tape speed ..... 4.76 cm/sec.  
 Wow & Flutter (WRMS) ..... 0.08%  
 Frequency response (70  $\mu$  S) ..... 30Hz - 20kHz ( $\pm 3$  dB)  
 Stereo separation (1 kHz) ..... 43 dB  
 Signal to Noise ratio (Dolby NR OFF) ..... 57 dB

### KRC-785, KRC-885W

#### FM Tuner section

Frequency range ..... 87.5 - 108.0 MHz  
 Channel space selection ..... 50 kHz / 200 KHz  
 Usable sensitivity (S/N=30dB) ..... 9.3 dBf (0.8  $\mu$  V/75  $\Omega$ )  
 Quieting Sensitivity (S/N=50dB) ..... 15.2 dBf (1.6  $\mu$  V/75  $\Omega$ )  
 Frequency response ( $\pm 3.0$ dB) ..... 30 Hz - 15 kHz  
 Signal to Noise ratio (MONO) ..... 70 dB  
 Selectivity ( $\pm 400$ kHz) .....  $\geq 80$  dB  
 Stereo separation (1 kHz) ..... 40 dB

#### AM Tuner section

Frequency range ..... 531 - 1611 kHz  
 Channel space selection ..... 9 K / 10 kHz  
 Usable sensitivity (S/N 20dB) ..... 28 dB  $\mu$  (25  $\mu$  v)

#### Cassette Player section

Tape speed ..... 4.76 cm/sec.  
 Wow & Flutter (WRMS) ..... 0.08%  
 Frequency response (70  $\mu$  S) ..... 30Hz - 20kHz ( $\pm 3$  dB)  
 Stereo separation (1 kHz) ..... 43 dB

(Dolby BNR ON) ..... 65 dB

KRC-PS955 (Dolby CNR ON) ..... 73 dB

#### Audio Section

##### Pre out level

KRC-PS955, KRC-805 ..... 4V/10k  $\Omega$  (with CD-CH)

KRC-705 ..... 1800 mV/10k  $\Omega$

##### Pre out Impedance

KRC-PS955, KRC-805 ..... 80  $\Omega$

KRC-705 .....  $\leq 600$   $\Omega$

Maximum output power ..... 40 W x 4

Full Bandwidth output power(at less than 1%THD) ..... 22 W x 4

Tone action (Bass: 100 Hz) .....  $\pm 10$  dB

(Treble: 10 kHz) .....  $\pm 10$  dB

#### General

Operating voltage ..... 14.4V(11- 16V allowable)

Current consumption ..... 10A at Rated power

Installation size (W x H x D) ..... 182m x 53mm x 161mm

7-3/16 x 2-1/16 x 6-5/16 (in)

Weight ..... 4.0 lbs (1.8 kg)

Signal to Noise ratio (Dolby NR OFF) ..... 57 dB

(Dolby BNR ON) ..... 65 dB

#### Audio Section

##### Pre out level

KRC-885W ..... 4V/10k  $\Omega$  (with CD-CH)

KRC-785 ..... 1800 mV/10k  $\Omega$

##### Pre out Impedance

KRC-885W ..... 80  $\Omega$

KRC-785 .....  $\leq 600$   $\Omega$

Maximum output power ..... 40 W x 4

Full Bandwidth output power(at less than 1%THD) ..... 22 W x 4

Tone action (Bass: 100 Hz) .....  $\pm 10$  dB

(Treble: 10 kHz) .....  $\pm 10$  dB

#### General

Operating voltage ..... 14.4V(11- 16V allowable)

Current consumption ..... 10A at Rated power

Installation size (W x H x D) ..... 182m x 53mm x 161mm

Weight ..... 1.8 kg

Note: The specifications and design of this unit are subject to continued technical development and may be changed without notice.

# KRC-705/759R/R/RY/785/805/859C /CY/R/R/RY/W/WY/885W/PS955

## SPECIFICATIONS

For Service Manuals Contact  
MAURITRON TECHNICAL SERVICES  
8 Cherry Tree Rd, Chinnor  
Oxon OX9 4QY  
Tel:- 01844-351694 Fax:- 01844-352554  
Email:- enquiries@mauritron.co.uk

### KRC-859C/CY/W/WY, KRC-859R/R/RY, KRC-759R/R/RY

#### FM Tuner section

Frequency range ..... 87.5 - 108.0 MHz  
Channel space ..... 50 kHz  
Usable sensitivity (S/N=26dB) ..... 0.7  $\mu$  V/75 ohms  
Quieting Sensitivity (S/N=46dB) ..... 1.6  $\mu$  V/75 ohms  
Frequency response ( $\pm$ 3.0dB) ..... 30 Hz - 15kHz  
Signal to Noise ratio (MONO) ..... 65 dB  
Selectivity ( $\pm$ 400kHz) .....  $\geq$ 80 dB  
Stereo separation (1 kHz) ..... 35 dB

#### MW Tuner section

Frequency range ..... 531 - 1611 kHz  
Channel space ..... 9 kHz  
Usable sensitivity (S/N 20dB) ..... 25  $\mu$  V

#### LW tuner section

Frequency range ..... 153 kHz - 281 kHz  
Usable sensitivity (S/N 20dB) ..... 45  $\mu$  V

#### Cassette Player section

Tape speed ..... 4.76 cm/sec.

Wow & Flutter (WRMS) ..... 0.08%  
Frequency response (70  $\mu$  S) ..... 30Hz - 20kHz ( $\pm$ 3 dB)  
Stereo separation (1 kHz) ..... 40 dB  
Signal to Noise ratio (Dolby NR OFF) ..... 57 dB  
(Dolby BNR ON) ..... 65 dB

#### Audio Section

Pre out level  
KRC-859C/CY/W/WY ..... 4V/10 K  $\Omega$  (with CD-CH)  
KRC-859R/R/RY, KRC-759R/R/RY ..... 1800 mV/10k ohms  
Pre out Impedance  
KRC-859C/CY/W/WY ..... 80  $\Omega$   
KRC-859R/R/RY, KRC-759R/R/RY .....  $\leq$ 600  $\Omega$   
Maximum output power ..... 40 W x 4  
output power(DIN45324, +B=14.4V) ..... 27 W x4  
Tone action (Bass: 100 Hz) .....  $\pm$ 10 dB  
(Treble: 10 kHz) .....  $\pm$ 10 dB

#### General

Operating voltage ..... 14.4V(11- 16V allowable)  
Current consumption ..... 10A at Rated power  
Installation size (W x H x D) ..... 182m x 53mm x 161mm  
Weight ..... 1.8 kg

Note: The specifications and design of this unit are subject to continued technical development and may be changed without notice.

## KENWOOD CORPORATION

14-6, Dogenzaka 1-chome, Shibuya-ku, Tokyo, 150 Japan

### KENWOOD SERVICE CORPORATION

P.O. Box 22745, 2201 East Dominguez Street,  
Long Beach, CA90801-5745, U.S.A.

### KENWOOD ELECTRONICS CANADA INC.

6070 Kestrel Road, Mississauga, Ontario, Canada L5T 1S8

### KENWOOD ELECTRONICS LATIN AMERICA S.A.

P.O. Box 55-2791, Piso 6, Plaza Chase, Cl. 47 y,  
Aquilino de la Guardia, Panama, Republic of Panama

### KENWOOD ELECTRONICS BRASIL LTDA.

Avenida Indianópolis, 628, 04062-001 Planalto Paulista,  
São Paulo-SP-Brasil

### KENWOOD ELECTRONICS UK LIMITED

Kenwood House, Dwight Road, Watford, Herts,  
WD1 8EB, United Kingdom

### KENWOOD ELECTRONICS DEUTSCHLAND GMBH

Rembrücker-Str. 15, 63150 Heusenstamm, Germany

### KENWOOD ELECTRONICS FRANCE S.A.

13, Boulevard Ney, 75018 Paris, France

### KENWOOD ELECTRONICS BELGIUM N.V.

Mechelsteeweg 418, B-1930 Zaventem, Belgium

### KENWOOD ELECTRONICS ITALIA S.p.A.

Via G. Sirtori 7/9, 20129 Milano, Italy

### KENWOOD IBÉRICA S.A.

Bolivia, 239-08020 Barcelona, Spain

### KENWOOD ELECTRONICS AUSTRALIA PTY. LTD.

(A.C.N. 001 499 074)  
8 Figtree Drive, Australia Centre, Homebush, N.S.W. 2140, Australia

### KENWOOD & LEE ELECTRONICS LTD.

Unit 3712-3724, Level 37, Tower 1, Metroplaza,  
223 Hing Fong Road, Kwai Fong, N.T., Hong Kong

### KENWOOD ELECTRONICS GULF FZE

P.O. Box 61318, Jebel Ali, Dubai, U.A.E.

### KENWOOD ELECTRONICS (THAILAND) CO., LTD.

573/111 Soi Ramkhamhaeng 39, Ramkhamhaeng Road,  
Wangthonglang, Bangkok, Bangkok, 10310 Thailand

### KENWOOD ELECTRONICS SINGAPORE PTE. LTD.

1 Genting Lane, #07-00, Kenwood Building, Singapore 349544

### KENWOOD ELECTRONICS (MALAYSIA) SDN BHD

#4.01 Level 4, Wisma Academy, Lot 4A, Jalan 19/1,  
46300 Petaling Jaya, Selangor, Malaysia